

Dell™ UPS Local Node Manager®

Installation and Configuration User's Guide

Notes

NOTE: A NOTE indicates important information that helps you make better use of your computer.

Information in this document is subject to change without notice.

© 2013 Dell Inc. All rights reserved.

Reproduction of these materials in any manner whatsoever without the written permission of Dell Inc. is strictly forbidden.

Trademarks used in this text: *Dell* and the *Dell* logo are trademarks of Dell Inc.; *Hyper-V*, *Microsoft*, *Windows*, *Internet Explorer*, *Windows Server*, *Windows 7*, *Windows XP*, and *Windows Vista* are either trademarks or registered trademarks of Microsoft Corporation in the United States and/or other countries; *Internet Explorer* is a registered trademark of Microsoft Corporation; *Firefox* is a registered trademark of the Mozilla Foundation; *Linux* is a registered trademark of Linus Torvalds; *Red Hat* is a registered trademark of Red Hat, Inc.; *Fedora* is a registered trademark of Red Hat, Inc.; *Safari* is a registered trademark of Apple Inc.; *Ubuntu* is a registered trademark of Canonical Ltd.; *VMware*, *ESX*, and *ESXi* are trademarks or registered trademarks of VMware, Inc.; *Mandriva* is registered trademark of Mandriva S.A.; *Novell* is a registered trademark of Novell, Inc. and *openSUSE* and *SUSE* are registered trademarks of Novell, Inc.; *Xen*, *XenServer*, *XenCenter*, and *XenMotion* are either registered trademarks or trademarks of Citrix Inc.; *Debian* is a registered trademark of Software in the Public Interest, Inc. (SPI); *Google* and *Chrome* are trademarks or registered trademarks of Google, Inc.; *GNOME* is a trademark of GNOME Foundation; *Opera* is a trademark of Opera Software ASA; *GNU* is a registered trademark of the Free Software Foundation.

Other trademarks and trade names may be used in this document to refer to either the entities claiming the marks and names or their products. Dell Inc. disclaims any proprietary interest in trademarks and trade names other than its own.

Table of Contents

1	Introduction	
2	Installation	
	Installation Prerequisites	13
	Systems Hosting Dell ULNM	13
	System with Web-based GUI Access	16
	Quick Start Installation	17
	Graphical Installation	17
	Configuration	19
	Operation	20
	Uninstalling the Dell ULNM (Standard Methods)	22
	Installing/Uninstalling the Dell ULNM (Command Line)	23
	Windows Installation	24
	Graphical Installation	24
	Silent Installation	25
	Installation Result	26
	Linux Installation	27
	Native Installation on a Red Hat, Suse, Mandriva, or Derivative System	27
	Native Installation on a Debian or Derivative System	28
	Generic installation on Linux	29
	Uninstalling the Linux Dell ULNM	30
	Upgrading the Product	30
3	Configuration	
	Discover UPSs Connected through USB/Serial	31

Discover Nodes Connected on the Network	31
Shutdown	32
Power Source	34
Edit Shutdown Configuration.	35
Edit Advanced Shutdown Criteria	38
Test Access	40
Test Shutdown	40
Shutdown Use Case	41
Configure Actions	46
Configure User Accounts	54
System Settings	56
Shutdown Controller	59
Notified Applications View	62

4 Supervision

Access to the Monitoring Interface	64
Local Access	64
Remote Access.	64
Power Source	64
Flexible Panels View	65
Panels List	66
Information and Status Panel	66
Measures Panel	67
Environment Panel	68
Graph Panel	69
Synoptic Panel	71
Events Panel	73
Statistics Panel.	74

Events	75
List Representation.	75
Calendar Representation.	76
Nodes Events List	77
Launching Device Web Interface	79

5 Redundancy

Redundancy Configuration	81
Redundancy Views	82
Composite Device in Power Source View	82
Power Components Sub View	83
Redundancy Use Cases	84

6 ULNM with Microsoft Hyper-V or Hyper-V Server

Installation Prerequisites	91
Hyper-V Manager/Hyper-V Server R1 and R2 Configuration Prerequisites	92
Dell ULNM Installation Prerequisites	97
Dell ULNM Network Configuration Prerequisites	97
Dell ULNM Installation (Hyper-V Server and Windows Server 2008)	97
Using Dell ULNM with Hyper-V Server R1/R2 or Hyper-V Manager	97
Local Access (for Hyper-V Manager on Windows 2008)	97
Remote access (for Hyper-V Server or Hyper-V Manager on Windows 2008)	98
SSL Mode	98
Configuration.	98
Operation.	99
References.	100

7 ULNM with VMware ESX Server 4.0 /4.1

Installation Prerequisites	104
VMware ESX Server 4.0 Configuration Prerequisites	104
Dell ULNM Installation Prerequisites	105
Dell ULNM Network Configuration Prerequisites	106
Dell ULNM Installation (VMware ESX Server 4.0, 4.1)	107
Silent Installation.	107
Using ULNM with VMware for ESX Server 4.0/4.1	108
Remote access (for VMware ESX Server 4.0, 4.1)	108
SSL Mode	108
Configuration	108
Operation.	109
References	110

8 ULNM with VMware ESXi Server 4.0/4.1/5.0

Installation Prerequisites	114
VMware ESXi Server 4.0/4.1/5.0 Configuration Prerequisites	115
Dell ULNM Installation Prerequisites	118
Dell ULNM Network Configuration Prerequisites	118
Dell ULNM Installation (VMware ESXi 4.0/ 4.1/5.0).	119
Silent Installation.	119
Using Dell ULNM with VMware for ESXi Server 4.0/4.1/5.0	120
Remote access (for VMware ESXi Server 4.0,/4.1/5.0)	120
SSL Mode	120
Configuration	120
Operation.	123
References	124

9 ULNM with Xen Virtualized Architecture

Citrix XenServer Architecture	128
Installation Prerequisites	129
Citrix XenServer Configuration Prerequisites	129
Dell ULNM Installation Prerequisites	130
Dell ULNM Network Configuration Prerequisites	130
Dell ULNM Installation (Citrix Xen)	131
Silent Installation.	132
References.	132
RHEL 5 and Debian 5.0 (Lenny) Architecture	133
Installation Prerequisites	134
RHEL 5 and Debian 5.0 (Xen Domain0) Configuration Prerequisites.	134
Dell ULNM Installation Prerequisites	134
Dell ULNM Network Configuration Prerequisites	134
Dell ULNM Installation (RHEL 5 and Debian 5.0)	135
Silent Installation.	135
References	135

10 ULNM with KVM Virtualized Architecture

Installation Prerequisites	140
KVM Configuration Prerequisites	140
Dell ULNM Installation Prerequisites	141
Dell ULNM Network Configuration Prerequisites	141
Dell ULNM Installation (KVM Enabled on RHEL 6 and Debian 5.0)	142
Silent Installation.	143
References	143

11 Troubleshooting

Messages or Issues and Solutions	144
HTML pages	144
Ubuntu's Software Center	144
Linux Graphical System Integration	144
Linux Network System Integration.	145
When Activating Shutdown Controller under Linux	146
Events and Actions with Some Windows x64 bits OS	146
Windows Vista Hibernate Sequence	146
Shutdown Sequence	147

Introduction

Dell™ UPS Local Node Manager® (ULNM) is protection software that gracefully shuts down computers and servers powered by a Dell UPS in the event of a power outage. The Dell ULNM acquires information through local or network communication using:

- Dell UPS USB or RS-232 communication ports
- Web/SNMP Cards (Dell™ Network Management Card H910P, also referred to as the NMC)

The Dell ULNM multilingual interface can be accessed from any computer with a connection to an Internet browser. The Dell ULNM protection software can be downloaded for no charge.

Figure 1 shows the Dell ULNM Main Page.

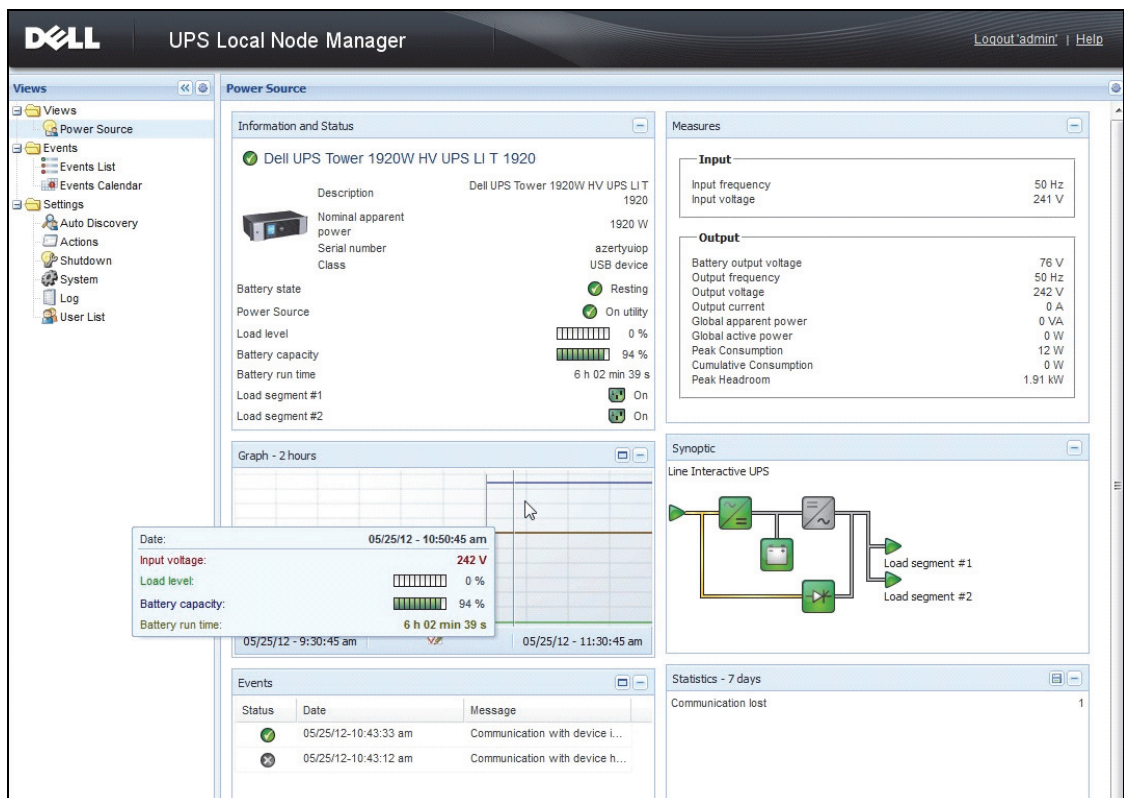

Figure 1. Dell ULNM Main Page

Advanced Management

The Dell ULNM can be remotely managed, configured, and updated using Dell™ Multi-UPS Management Console® (MUMC) supervisory software. Using the Dell MUMC, you can perform mass configurations and mass updates of Dell ULNM applications. The Dell MUMC can also remotely perform the following:

- Display a Dell ULNM Release 2 configuration
- Configure a single Dell ULNM Release 2
- Synchronize multiple Dell ULNM Release 2 configurations
- Trigger Dell ULNM Release 2 instances upgrade

The Dell MUMC can be downloaded for no charge. More details are available in Dell MUMC user’s guide.

Compatibility

Serial Line Devices

The Dell ULNM is compatible with the following serial line devices (see Table 1).

Table 1. Serial Line Devices

Dell Equipment Designation	Connectivity Type
500 Watt, 1000 Watt, 1920 Watt, 2300 Watt, 2700 Watt Rack/Tower	USB or RS-232
Short Depth High Efficiency Online 2700 Watt	USB or RS-232
High Efficiency Online 3750 Watt, 4200 Watt, 5600 Watt	USB or RS-232
LI 5600 Watt Rack	USB or RS-232
Online 10 kW Rack	USB or RS-232

Network Devices

The Dell ULNM is compatible with the following network device (see Table 2).

Table 2. Network Device

Dell Equipment Designation	Network Device Type
Dell Network Management Card SNMP/Web H910P	UPS Option Card



Dell Applications

The Dell ULNM is compatible with the following applications (see Table 3).

Table 3. Applications

Dell Equipment Designation	Application Type
Computers (Windows® - Linux®) hosting the Dell ULNM Shutdown Controller	UPS Proxy (Shutdown Controller)
Features: <ul style="list-style-type: none">• Quick Scan• Supervision• Management• Shutdown	

Terms

This section provides related terms and definitions.

IP address

When Transmission Control Protocol / Internet Protocol (TCP/IP) is installed on a computer, an Internet Protocol (IP) address is assigned to the system. Each address is unique and is made up of four numbers, each between 0 and 256, such as 168.8.156.210.

Network Management System

The Network Management System (NMS) supervises SNMP devices connected to the TCP/IP Network.

Network Shutdown Module

The Network Shutdown Module is a software module that uses the information transmitted by the Dell Network Management Card/Proxy to inform computer users on the current status of the electrical power supplied to the computer.

If the supply of the electrical power from the UPS is at risk, the Network Shutdown Module initiates an orderly shutdown of the computer under the most secure conditions possible.

RSA Algorithm

An algorithm for public-key cryptography encryption protocol. An RSA key is the result of operations involving prime numbers. RSA refers to Ron Rivest, Adi Shamir, and Leonard Adleman, who described public-key cryptosystems in 1978.

Secure Socket Layer

The Secure Socket Layer (SSL), created by Netscape, is a solution for securing transactions over the internet. SSL is a communication protocol that authenticates the data exchanged, as well as ensuring its confidentiality and integrity. The protocol uses a recognized encryption method, the RSA algorithm with a public key. SSL is built into Internet Web browsers. The padlock in the bottom of your browser screen is automatically displayed if the server sending information uses SSL.

Transmission Control Protocol / Internet Protocol

TCP/IP is a family of network and communication protocols for the transport and network layers. Also known as the Internet Protocol suite of network communication protocols.

Acknowledgements

The Dell software development team is grateful to the following projects:

- Spider Monkey
- JSMiniNSPR
- Ext JS
- SQLite
 - The SQLite Project (<http://www.sqlite.org/>) generously donated source code to the public domain that helped us for this project.
- Open SSL
 - This Dell UPS Local Node Manager (ULNM) product includes software developed by the OpenSSL Project for use in the OpenSSL Toolkit (<http://www.openssl.org/>).
 - This DELL ULNM product includes cryptographic software written by Eric Young (ey@cryptsoft.com).
 - This DELL ULNM product includes software written by Tim Hudson (tjh@cryptsoft.com).
- Lib USB
- Net SNMP

The full license version for each of these projects is available from Dell ULNM using the **Settings >System > About** selection path.

Installation

This chapter provides Dell UPS Local Node Manager (ULNM) installation prerequisites, quick start installation procedures, command line procedures, and installation procedures for Microsoft Windows and Linux operating systems. Procedures for uninstalling the product are also included.

Installation Prerequisites

This section provides installation prerequisites for the following:

- Systems hosting the Dell ULNM
- Systems that display the Web-based graphical user interface (GUI)

Systems Hosting Dell ULNM

Table 4. Supported Operating Systems

Operating System	Service Pack	Type of Message	Platform	
			x86	x64
Microsoft Windows				
Windows Server® 2012	Windows Server 2012 Standard, Enterprise, Datacenter	Latest	—	•
Windows Server 2011	Windows Small Business Server 2011 Standard	Latest	—	•
Windows Server 2008	Windows Server 2008 R2 Standard, Enterprise, Datacenter	SP1	—	•
	Windows Server 2008 R1 Standard, Enterprise, Datacenter	SP2	•	•
	Windows Server 2008 Small Business Server R2	Latest	•	•
	Windows Server 2008 Small Business Server	Latest	•	•
	Windows Server 2003	Windows Server 2003 Standard, Enterprise, Datacenter R2	SP2	•
Windows Server 2003	Windows Server 2003 Standard, Enterprise, Datacenter R1	SP1	•	•
	Windows Small Business Server 2003 Standard, Enterprise, Premium R2	Latest	•	—

Operating System	Service Pack	Type of Message	Platform	
			x86	x64
Windows 8	(Enterprise, Premium, Professional, Ultimate, Basic)	Latest	•	•
Windows 7	Windows 7 (Enterprise, Premium, Professional, Ultimate, Basic)	SP1	•	•
Windows Vista®	Windows Vista (Enterprise, Ultimate, Business)	SP2	•	•
Windows XP®	Windows XP Professional	SP3	•	—
Linux				
Red Hat® Enterprise Linux®	Red Hat Enterprise Linux 6.4		•	•
	Red Hat Enterprise Linux 6.3		•	•
	Red Hat Enterprise Linux 6.2		•	•
	Red Hat Enterprise Linux 6	U2	•	•
	Red Hat Enterprise Linux 6	U1	•	•
	Red Hat Enterprise Linux 5.9		•	•
	Red Hat Enterprise Linux 5.8		•	•
	Red Hat Enterprise Linux 5.7		•	•
	Red Hat Enterprise Linux Advanced Platform 5.4 (Latest Update)	U7	•	•
	Red Hat Enterprise Linux Version 5	U7	•	•
	Fedora core 18		•	•
	Fedora core 15	U6	•	•
	Fedora core 14		•	•
SUSE®/Novell®	SUSE Linux Enterprise Server 11	SP2	•	•
	SUSE Linux Enterprise Server 11	SP1	•	•
	SUSE Linux Enterprise Server 10	SP4	•	•
SUSE/Novell	OpenSuse 12.2		•	•
	OpenSuse 11.4	SP4	•	•
	OpenSuse 11.2		•	•
Debian® GNU® Linux®	Debian 6 (Squeeze)		•	•
	Debian 5 (Lenny)		•	•

Operating System	Service Pack	Type of Message	Platform	
			x86	x64
Ubuntu®	12.10		•	•
	12.04 LTS		•	•
	11.10		•	•
	10.04 LTS		•	•
Virtual Environments				
VMware®	ESXi 5.1 (pay version only)		—	•
	ESXi 5.0 (pay version only)	U1	—	•
	ESXi 4.1 (pay version only)	U2	—	•
	ESX 4.0 (pay version only)	U4	—	•
Microsoft HyperV™	Windows Hyper-V Server 2012		—	•
	Windows Hyper-V Server 2008	R2	—	•
	Windows Hyper-V Server 2008		—	•
Xen®	Citrix XenServer 6.0		•	•
	Citrix XenServer 5.6		•	•
	OpenSource Xen 2.6 on RHEL 5		—	•
	OpenSource Xen 3.2 on Debian 5		—	•
KVM	KVM 0.12.1.2 on RHEL 6 and Debian 5		—	•

For x86-64 architectures, on Windows system, the Dell ULNM will work in 32-bit compatibility mode, which implies no native ports for these architectures will be made for these systems except for components that strictly require it, such as device drivers.

On all supported platforms, the Dell ULNM will run as a service and will automatically start at system boot up as soon as required system services (essentially network) are up.

For the installation in these specific virtual environments, please refer to the user manual appendix that describes the procedures for those environments.

The Linux package is based on standard Linux mechanisms and therefore can be installed and used with other Linux distributions. Feedbacks / test or bug reports are welcome at Dell support.

Note that the list in is not exhaustive, but that the Dell ULNM should be compatible with the architectures listed in Table 5.

Table 5.Supported Linux x86-64 Architectures

Linux (x86/x86_64)	
Debian GNU Linux	Etch, Testing
SUSE/Novell	LES 10, OpenSUSE® 10.3
Red Hat Enterprise Linux	Fedora™ core 13
Ubuntu	8.04, 8.10, 9.04, 9.10, 10.10
Mandriva®	2010, 2011
CentOS	5.4, 5.4, 6

Software Compatibility Limitations

To avoid network or serial port access conflicts, you cannot install the Dell ULNM on a machine that also hosts:

- Dell UPS Management Software

NOTE: This is the previous Dell software for managing UPSs. If you were using it previously, please remove it before installing the new Dell ULNM software)

- Dell™ Multi-UPS Management Console® (MUMC)

Standby Configuration (Windows)

In Configuration **Control Panel > Power Option** properties, you must deselect the standby configuration of your Operating System to be compliant with the Dell ULNM. With the standby configuration checked, your system is not protected.

 **NOTE:** If you want to save energy, use the hibernate feature.

Driver Installation

The Dell ULNM installs all the necessary drivers (when connecting to Dell UPS by USB or serial). If the Windows Operating System wants to install a driver from “Windows Update,” you can cancel this process.

System with Web-based GUI Access

Dell ULNM graphical interface can be accessed remotely using a simple Web browser. Access to this interface can be secured through SSL connection and is also secured through login and password.

The Dell ULNM graphical interface has been tested with:

- Google® Windows Chrome™ 17, 19, 25
- Mozilla Firefox® 3.0, 3.5, 12, 13
- Mozilla Windows® Firefox 19

- Mozilla Linux Firefox 10 (RedHat)
- Mozilla Linux Firefox 18 (Ubuntu)
- Microsoft Windows Internet Explorer® 6(*), 7, 8, 9,10 (*) IE6 should work but the performance is not optimal
- Opera™ 11, 12
- Safari® 5.1

 **NOTE:** For optimal performance, Google Chrome 19 or Firefox 12 is recommended. For good performance, Firefox 3.5 or Internet Explorer 7, 8 is suggested.

 **NOTE:** New 2013 system releases are expected for Fedora, Debian, OpenSuse, and Ubuntu OS. Validation is performed with the latest Browser version available for each supported OS at the time of the Dell ULNM release.

Quick Start Installation

This section includes quick start installation and configuration instructions.

Graphical Installation

To install the Dell ULNM:

- 1 On a Windows 2000/XP/2003/Vista/2008/7 and Linux machine, run the Dell UPS Local Node Manager package under an administrator account. A Web browser displays the Dell UPS Local Node Manager Installer Welcome screen.
- 2 Observe the prompt and verify that the communication device is connected. Click **Next** (see Figure 2). The Login screen displays.

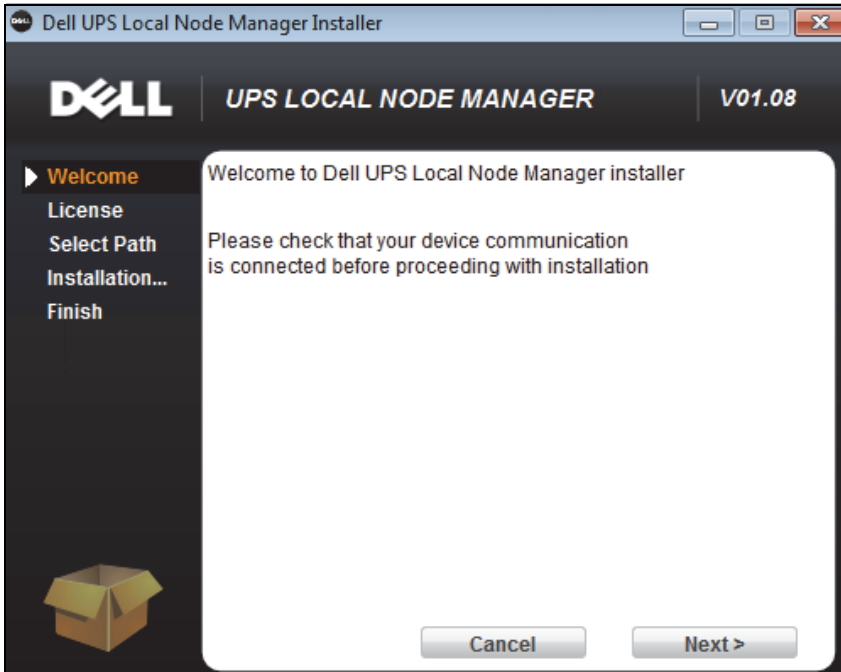



Figure 2. Welcome Screen

- 3 Read the application description. Type the login and password and click **Login** (see Figure 3).

 **NOTE:** The default entry for login and password is **admin**.

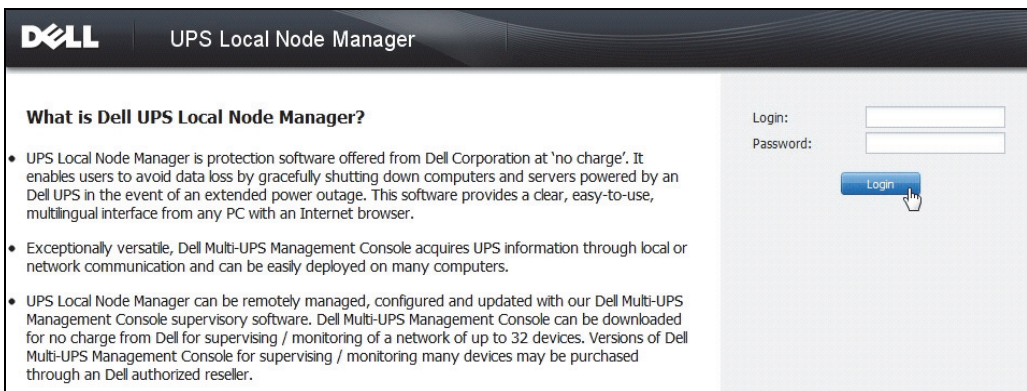



Figure 3. Login Screen

Configuration

When started, the application automatically performs a discovery using the “Quick Scan” option for the following UPSs:

- Serial line connected UPSs (RS-232 or USB)

The discovered UPS connected through an RS-232 or USB connection is automatically assigned as the Power Source. The Status icon is automatically green  in the Node List page (see Figure 4).

- Networked UPSs through broadcast within a few seconds. “Quick Scan” is compatible with Web/SNMP Cards such as the Dell Network Management Card (H910P).

The discovered Networked UPSs are not automatically assigned as the Power Source. You must select the node and click **Set as Power Source**. The Status icon becomes green  in the Node List page (see Figure 4).

The Edit Shutdown Configuration dialog box displays (see Figure 5). You can configure your power source now or by using the “Edit shutdown configuration” setting, which will show the same configuration dialog box.

- The discovered nodes are displayed using **Settings > Auto Discovery** (see Figure 4).

For the other nodes, perform the discovery based on IP address ranges using the “Range Scan” option. Using “Range Scan” discovers the nodes that are outside of the network segment (subnet).

(Optional) Use **Settings > Shutdown** to display the Edit Power Source dialog box and assign the following:

- IP address of the UPS that powers the local Computer (if not already set by the previous step).
- Use **Settings > User List** to assign access rights for users through the login and password entries.

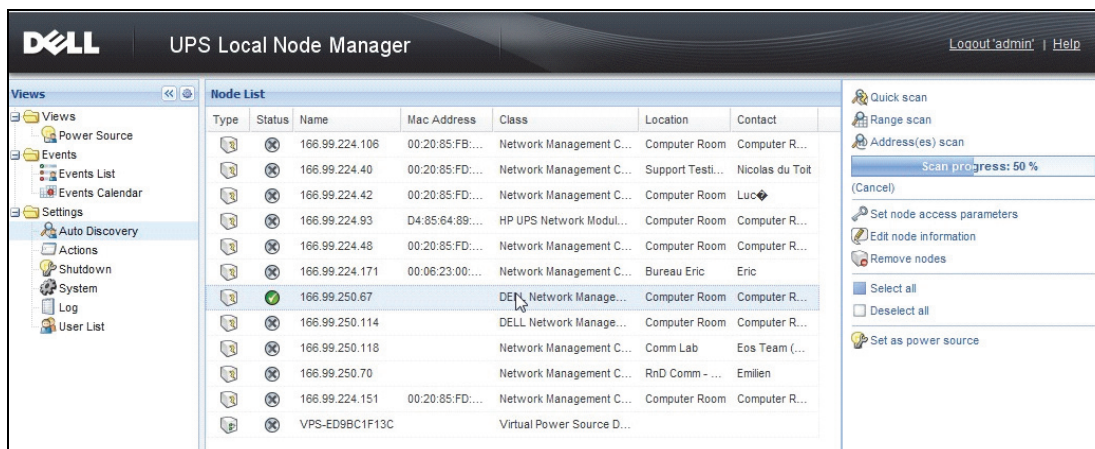

Figure 4. Quick Start - Auto Discovery Page

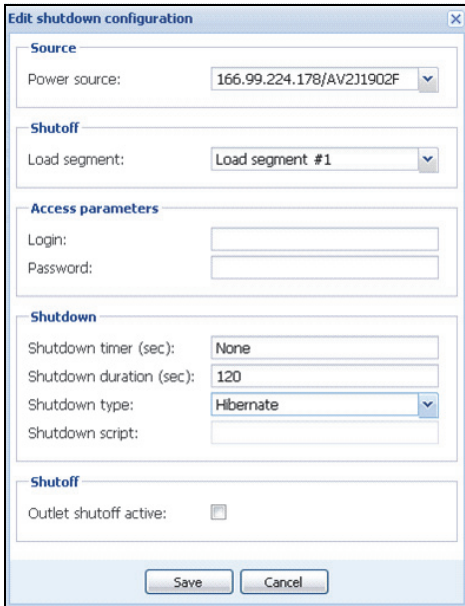

Figure 5. Quick Start - Edit Shutdown Configuration

Operation

Use **Views > Power Source** (optional) to supervise the current state of the UPS that powers the server running the Dell ULNM (see Figure 6).

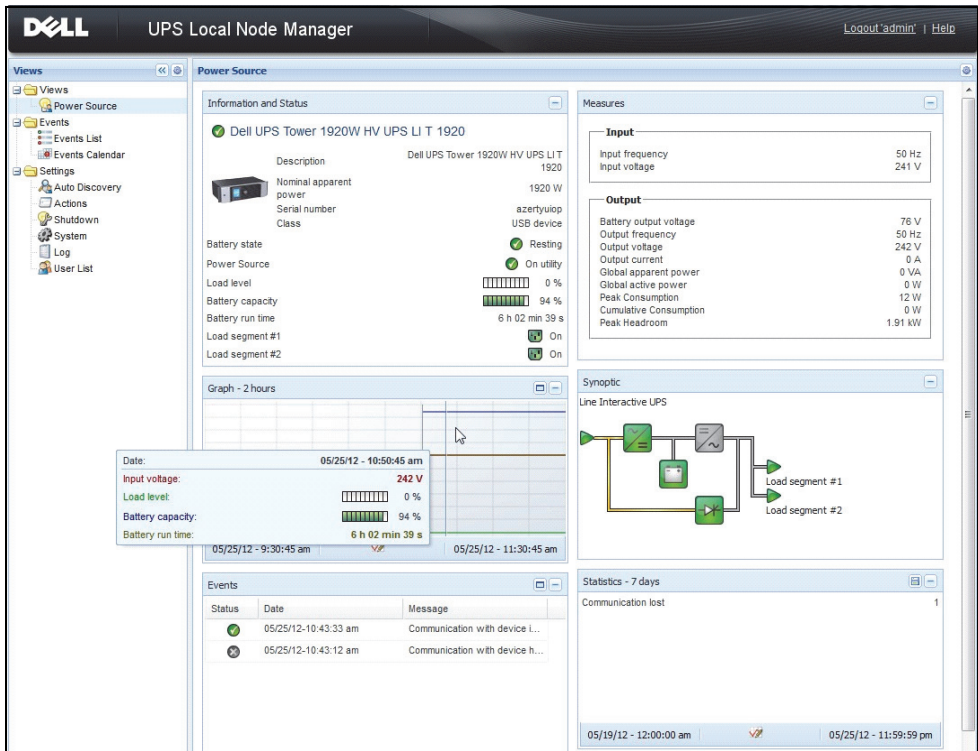

Figure 6. Quick Start - Power Source Main Page

The **Events > Event List** view allows you to view the device events (see Figure 7).

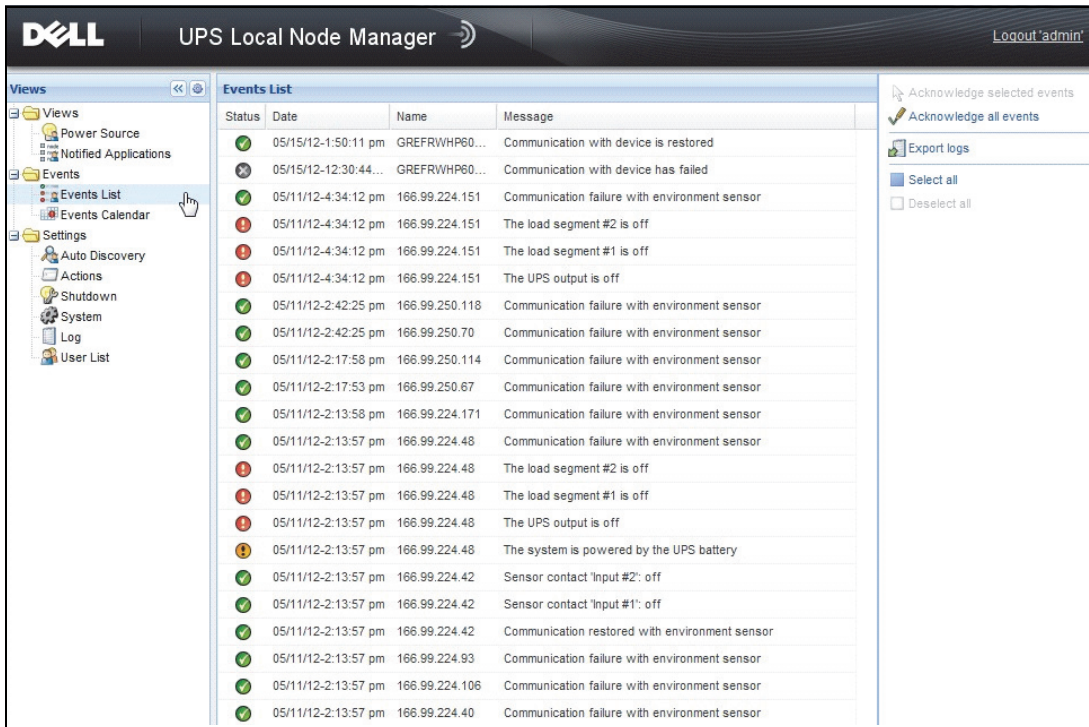

Figure 7. Quick Start - Events List Page

Uninstalling the Dell ULNM (Standard Methods)

Two standard methods for uninstalling the Dell ULNM are available:

- From the Add/Remove programs item of the control panel, select the Dell UPS Local Node Manager Vx.xx package to remove it.
- You can also uninstall from the shortcuts to remove the product and custom files (if you confirm the action):

Start > Programs Dell > UPS Local Node Manager > Uninstall Dell UPS Local Node Manager

NOTE: This removes the database and the custom files if you confirm it.

Installing/Uninstalling the Dell ULNM (Command Line)

You can install or uninstall the product from a command line in order to deploy the software in a group, with or without using the graphical interface. This method also provides the ability to configure protection settings from the command line.

- Detail of available command options can be obtained using command:
 - `<packageName> -help`
 - `<packageName> [COMMAND] [OPTION]...`
- The available commands are:
 - `-install` Launches the installation/upgrade process (default).
 - `-uninstall` Launches the process to uninstall the application.
- The available options are:
 - `-debug` Displays debugging information on the console.
 - `-silent` Install the application silently.
- Access the installation folder:
 - `-dir <installPath>`
- Power source settings can be provided with:

```
-sdn <login>:<password>@<address>,<loadSegment>,  
<shutdownDuration>,<shutdownTimer>,<shutoffControl>
```

Example

To install Dell ULNM silently in C:\Program Files\MyFolder:

```
<packageName> -install -silent -dir "C:\Program Files\MyFolder"  
-sdn admin:admin@192.168.100.101,1,120,-1,1
```

Dell ULNM installs with shutdown feature parameters

- Power source: 192.168.100.101
- Login: admin
- Password: admin
- Load segment: 1 (Master)
- Shutdown duration: 120 seconds
- Shutdown timer: -1 (None)
- Shutoff control: 1 (Enabled)

After the installation is completed, open a Web browser with the following URL:

<http://<host>:4679/>, *where* <host> is the host name or IP address of the machine hosting Dell ULNM.

Windows Installation

Graphical Installation

To install the Dell ULNM:

- 1 Run the Dell UPS Local Node Manager package under an administrator account. A Web browser displays the Dell UPS Local Node Manager Installer Welcome screen.
- 2 Observe the prompt and verify that the communication device is connected. Click **Next** (see Figure 8).

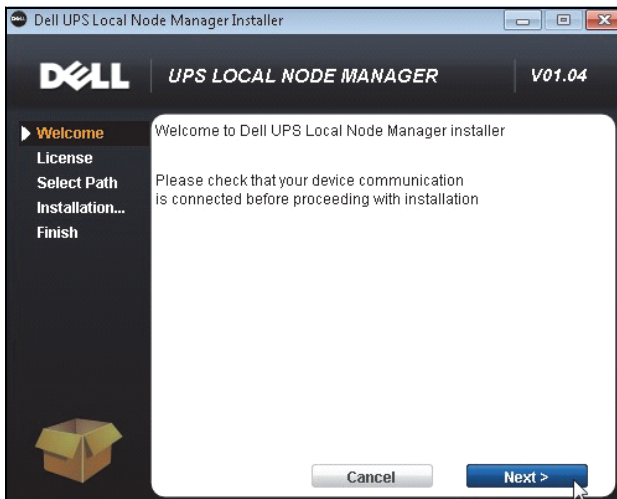

Figure 8. Welcome Screen

- 3 Read the application description. Type the login and password and click **Login** (see Figure 9).

NOTE: The default entry for login and password is **admin**.

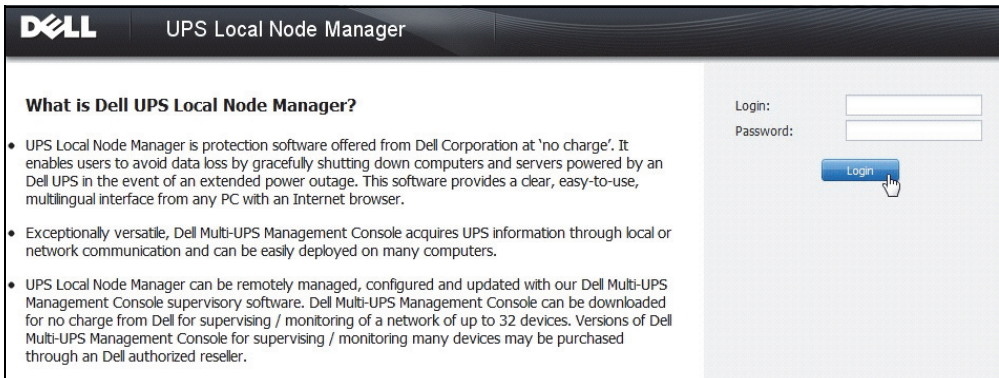

Figure 9. Login Screen

NOTE: If the browser does not open as planned, it should be started manually and pointed to <http://127.0.0.1:4679/>.

Silent Installation

The silent installation is performed in command line mode (without user interaction).

To install the Dell ULNM:

- 1 At the command line prompt, type the following:
`<Dell ULNM package name> -install -silent`
- 2 When the installation is completed, open a Web browser with the following URL:
<http://<@IP>:4679/> (where <@IP> is the IP address of the machine hosting the Dell ULNM)

Refer to the following configuration notes:

- To configure the IP address of the Power Source, you can use the Dell Multi-UPS Management Console® (Dell MUMC) mass configuration feature.
- You can also use the command line to configure the power source:
`<DELL ULNM package name> -install -silent -sdn
<login>:<password>@<address>,<loadSegment>,<shutdownDuration>,
<shutdownTimer>,<shutoffControl>`
- The -help option describes the different options available (see Figure 10).

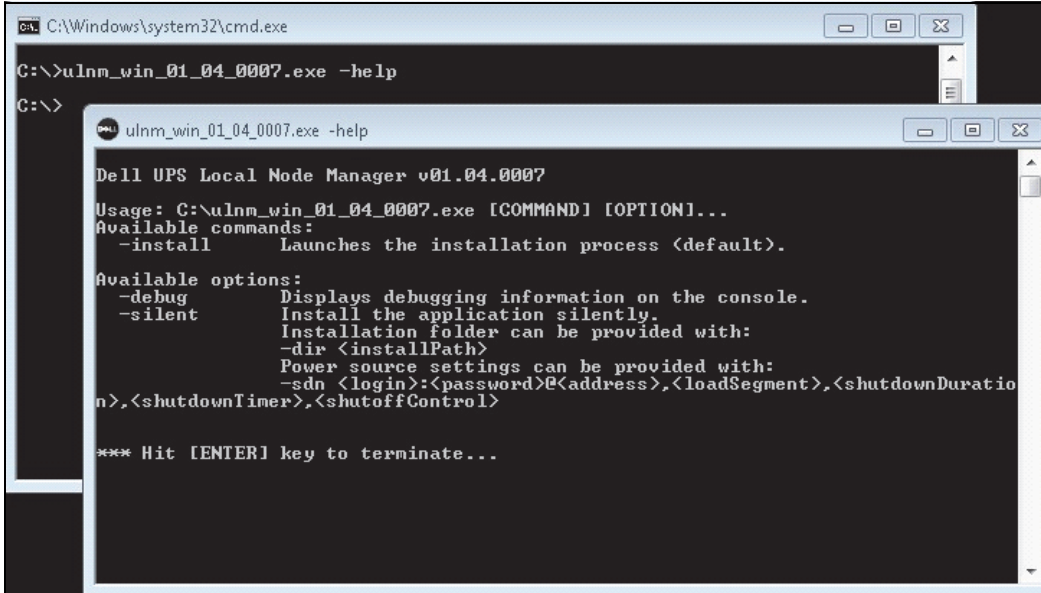

```
C:\Windows\system32\cmd.exe
C:\>ulnm_win_01_04_0007.exe -help
C:\>
ulnm_win_01_04_0007.exe -help

Dell UPS Local Node Manager v01.04.0007
Usage: C:\ulnm_win_01_04_0007.exe [COMMAND] [OPTION]...
Available commands:
  -install      Launches the installation process <default>.

Available options:
  -debug        Displays debugging information on the console.
  -silent       Install the application silently.
                Installation folder can be provided with:
                -dir <installPath>
                Power source settings can be provided with:
                -sdn <login>:<password>@<address>,<loadSegment>,<shutdownDuration>,<shutdownTimer>,<shutoffControl>

*** Hit [ENTER] key to terminate...
```

Figure 10. Command Line Installation Options

Installation Result

If you install a new Dell ULNM release without uninstalling the old one, you will keep your database and your product settings.

- At the end of the installation, the following shortcuts are created in the group **Start > Programs File > Dell > UPS Local Node Manager**:
 - Open Dell UPS Local Node Manager: Starts the main Dell UPS Local Node Manager graphical interface
 - Start Dell UPS Local Node Manager: Starts the service
 - Stop Dell UPS Local Node Manager: Stops the service
 - Uninstall Dell UPS Local Node Manager: Uninstalls the program
- A service called “Dell UPS Local Node Manager” is also created for the Database Acquisition Engine.
 - This service automatically starts on machine boot-up.
 - This service provides the Web Interface.
- A System Tray Icon displays the alarms on the local computer. Right-click this icon to display the same shortcuts as the Windows Start menu.

Linux Installation

Dell ULNM for Linux is available both in native package form (.deb or .rpm) and as a generic installer for Command Line Interface (CLI).

Native Installation on a Red Hat, Suse, Mandriva, or Derivative System

Graphical Installation

To install graphically:

- 1 Double-click the Dell UPS Local Node Manager.rpm package.
- 2 The system prompts for the root password. Enter the root password. The system launches a graphical front end, such as Red Hat's package Installer, as shown in Figure 11.

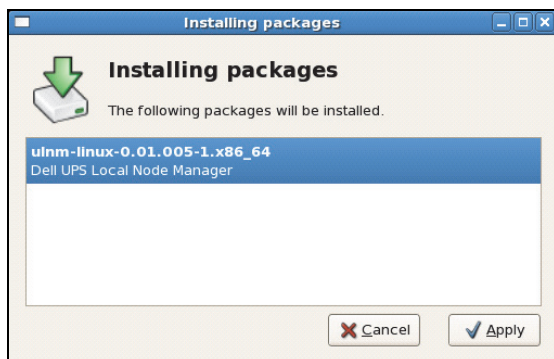

Figure 11. Linux RPM Graphical Package

Command Line Installation

To install from the command line:

- 1 At the command line prompt, type the command (as root):
`$ rpm -i ulnm-linux_X.Y.Z.rpm`

Example command line installation:

```
$ rpm -ivh ulnm-linux-0.01.003-1.i386.rpm
Preparing... ##### [ 100% ]
 1:ulnm-linux ##### [ 100% ]
```

- 2 When the installation is completed, open a Web browser with the following URL:
`http://<@IP>:4679/` (where <@IP> is the IP address of the machine hosting the Dell ULNM)

Native Installation on a Debian or Derivative System

Prerequisite

On Debian (Lenny), there is no default graphical installer present.

You should either use the command line installation that follows, or install the package “gdeb” and “gdebi” and restart your graphical session to be able to complete the present procedure.

NOTE: This is a known Debian bug, which is registered in the Debian Bug Tracking System: <http://bugs.debian.org/585183>

Graphical Installation

To install graphically:

- 1 Double-click Dell UPS Local Node Manager.deb package.
- 2 The system prompts for the root password, and then launches a graphical front end, such as Gdebi, as shown in Figure 12:

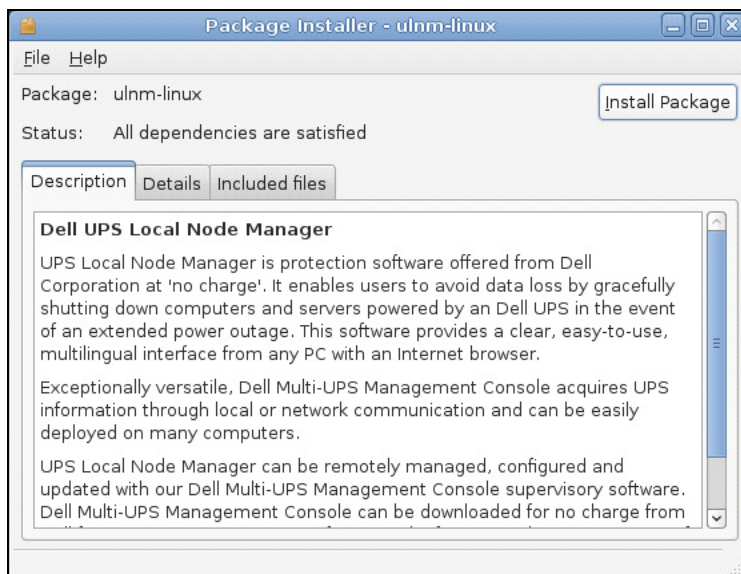

Figure 12. Dell ULNM Linux GDB Graphical Package Installer

- 3 Click **Install Package**.
- 4 Once the installation is completed, open the menu **Application > Dell > UPS Local Node Manager > Open** (in Gnome™), then follow the instructions in the Configuration chapter of this document.

Command Line Installation

To install from the command line:

- 1 At the command line prompt, type the command (as root):
`$ dpkg -i ulnm-linux_X.Y.Z.deb`

Example command line installation:

```
$ dpkg -i ulnm-linux_0.01.003-1_i386.deb
(Reading database ... 352242 files and directories currently
installed.)
Preparing to replace ulnm-linux 0.01.003 (using .../ulnm-
linux_0.01.003-1_i386.deb)...
Unpacking replacement ulnm-linux ...
Setting up ulnm-linux (0.01.003)...
```

- 2 When the installation is completed, open a Web browser with the following URL:
`http://<@IP>:4679/` (where <@IP> is the IP address of the machine hosting the Dell ULNM)

Generic installation on Linux

If your system does not derive from Red Hat (.rpm) or Debian (.deb), you can install Dell ULNM using the generic package.

NOTE: This method is only supported from the command line.

To install from a command line in interactive mode:

- 1 Use the following command from where the generic installer is located (as root):
`$ ulnm-linux-0x_0x_000x-i386 -install`
- 2 For silent installation, add the “silent” parameter (as root):
`$ ulnm-linux-0x_0x_000x-i386 -install -silent`
- 3 When the installation is completed, open a Web browser with the following URL:
`http://<@IP>:4679/` (where <@IP> is the IP address of the machine hosting the Dell ULNM)

Uninstalling the Linux Dell ULNM

If you have chosen the native packages, you can use your preferred packages management application to remove (uninstall) the “ulnm-linux” package.

You can also do the same from the command line.

For example:

- On Red Hat and derivatives, use:
`$ rpm -e ulnm-linux`
- On Debian and derivatives, use:
`$ dpkg -r ulnm-linux`

NOTE: After uninstalling the native .deb or .rpm packages, some user's configuration and data are not removed, due to technical constraints.

- If you want to fully remove these, use the following command (as root):
`$ rm -rf /usr/local/Dell/UPSLocalNodeManager`
- If you have chosen the generic installer, use the following command for interactive uninstall (as root):
`$ /installation/path/mc2 -uninstall`
- For silent uninstall, add the “silent” parameter (as root):
`$ /installation/path/mc2 -uninstall -silent`

Upgrading the Product

If you install a new Dell ULNM Release without uninstalling the old release, you will keep the database and product information from the old release.

Configuration

This chapter describes how to configure the Dell UPS Local Node Manager (ULNM).

Discover UPSs Connected through USB/Serial

- 1 Start the Dell UPS Local Node Manager main graphical interface from the previously created shortcut.
- 2 Click the **Settings-> Auto Discovery** menu item.
- 3 The first discovered UPS connected through RS-232 or USB is automatically assigned as the Power Source. Identify the Power Source by the green status symbol , as shown in Figure 13.

NOTE: When the Power Source is configured, the icon becomes green if the configuration is successful or gray if the communication fails.

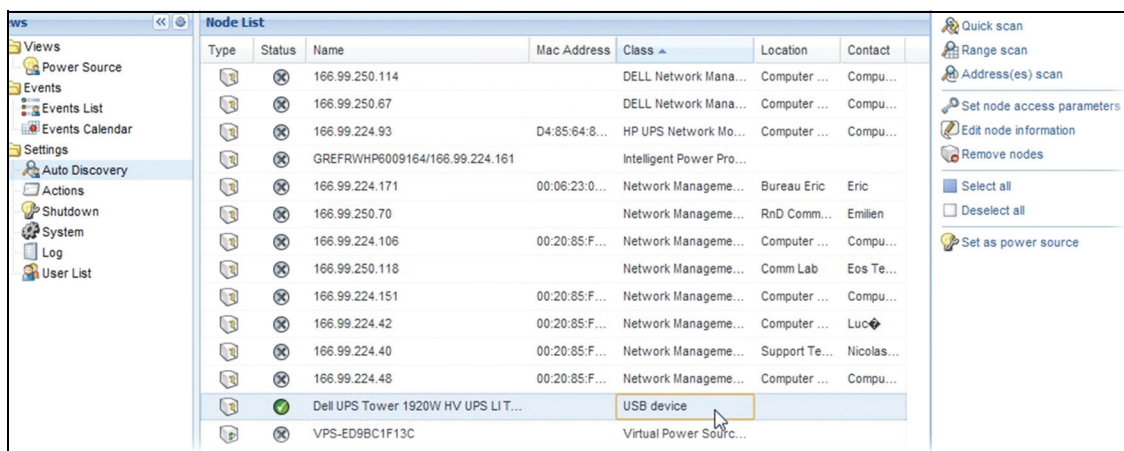

Figure 13. Dell ULNM UPS Discovery

Discover Nodes Connected on the Network

From **Settings > Auto Discovery**, the following discovery methods are available:

- “Quick Scan” (automatically performed when application starts)
- “Range Scan”
- “Address Scan”

The following operation notes apply when discovering nodes:

- Each network node (Dell Network Management Card...) must have a valid IP address (or a DNS name) in the range that you have entered for auto discovery. Refer to the compatibility list in “Compatibility” on page 10.
- The Dell ULNM automatically receives the alarms (through notification or polling).
- The “Quick Scan” request is a Broadcast frame on 4679 IANA reserved port and 69 standard TFTP port. Using the “Quick Scan” operation, you will discover through broadcast within a few seconds following Web/SNMP cards.
- For the nodes outside of the network segment, perform the discovery based on IP address ranges using the “Range Scan” option.
- “Address Scan” performs a single address scan.
- None of the discovered UPSs that are connected through (Network) are automatically assigned as the Power Source. You must select the node and click the **Set as Power Source** button.
- The Edit Shutdown Configuration dialog box opens automatically when the Power Source is set.

Shutdown

Dell ULNM provides local computer graceful shutdown with an acquisition through the USB/serial or network (Web/SNMP cards).

To access the shutdown configuration options:

- 1 Login with an administrator user profile.
- 2 Select **Settings > Shutdown**. The Shutdown page is displayed (see Figure 14).

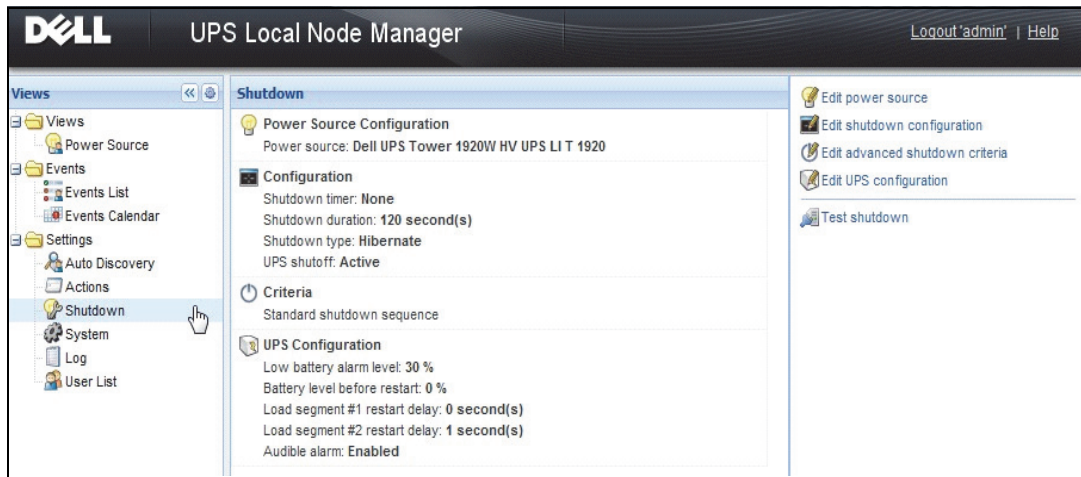

Figure 14. USB/Serial Power Source on Shutdown Page

The following configuration options are provided on the right-side panel of the Shutdown page:

- Edit power source
- Edit shutdown configuration
- Edit advanced shutdown criteria
- Test access
- Test shutdown

NOTE: Check the settings for the UPS shutoff option to ensure the expected behavior: with the “UPS shutoff” option enabled, the shutdown sequence test will lead to the full UPS shutdown (see Figure 15).

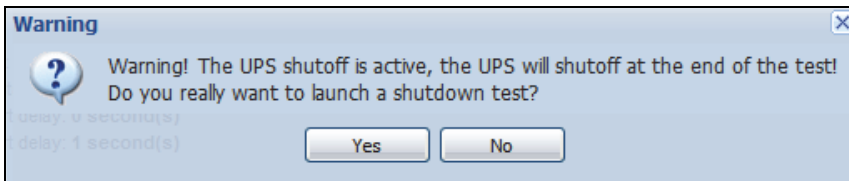

Figure 15. Test Shutdown Warning Message

- Run Battery test: Launch a battery test if the following conditions are true:
 - Battery must be in rest mode.
 - The load must be over 25%.
- Run UPS Upgrade Tool if the following conditions are true (see Figure 16):
 - A power source has been set up in the software.
 - The Dell UPS Upgrade Tool is installed on the operating system.
- Run UPS Logs Extraction Tool if the following conditions are true:
 - A power source has been set up in the software.
 - The Dell UPS Logs Extraction Tool is installed on the operating system.
 - Communication with UPS through a serial connection.
 - It is installed on a Windows Operating System in the list of supported OS.

NOTE: If the Dell UPS is connected through the USB or if the software is running on a Linux Operating System (not supported by the “Dell UPS Logs Extraction Tool,” the button will be disabled.

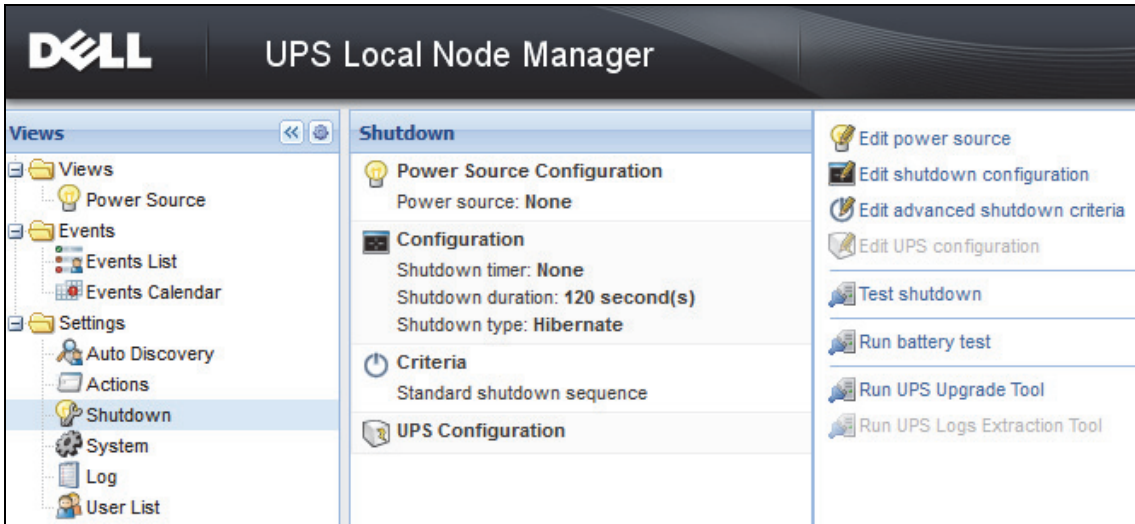

Figure 16. Run UPS Upgrade Tool in Shutdown Panel

Power Source

To configure Power Source:

- 1 Login with an administrator user profile.
- 2 Select **Settings > Shutdown**. The Shutdown page is displayed.

NOTE: You can retrieve the UPS History Logs by clicking **Run Log UPS extraction tool**.

- 3 Click **Edit Power Source**. The Edit Power Source dialog box displays (see Figure 17).

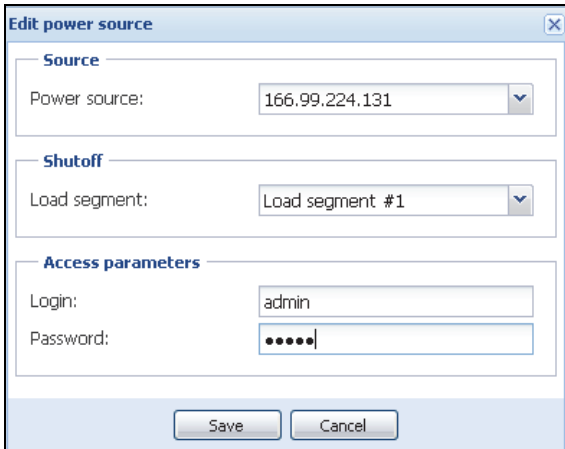

Figure 17. Edit Power Source Dialog Box

1 In the Power source field, select the UPS that powers the computer hosting the Dell ULNM.

NOTE: This settings is also accessible through **Settings > Auto-Discovery > Set as Power Source**.

2 Change parameters as needed.

3 Click Save.

Source Parameter

The Power source value is the IP address of the UPS that powers the computer hosting the Dell ULNM.

Shutoff Parameter

The load segment value is the load segment that powers the server hosting Dell UPS Local Node Manager, when available.

WARNING: NOT available through USB connection and in shutdown controller mode

NOTE: When “Master” is selected, the entire UPS will switch off.

Access Parameters

Access parameter are used when the Power Source is managed through the network.

If the Power Source is an Ethernet card (Dell Network Management Card H910P), a login and password are needed in order to synchronize the settings between the Dell ULNM and the Dell Web/SNMP Card, such as when changing the shutdown duration value.

NOTE: If this synchronization is not provided, the system will have conflicting instructions on power events. If the Power Source is another Dell ULNM with the shutdown controller feature activated, then login and password are mandatory. The Login must be the “admin” account.

Edit Shutdown Configuration

To configure Shutdown Parameters:

NOTE: The “Edit shutdown configuration” window opens automatically when the power source is set.

1 Login with an administrator user profile.

2 Select **Settings > Shutdown**. The Shutdown page is displayed.

3 Click **Edit shutdown configuration**.The Edit Shutdown Configuration dialog box displays (see Figure 18).

4 Change parameters as needed.

5 Click Save.

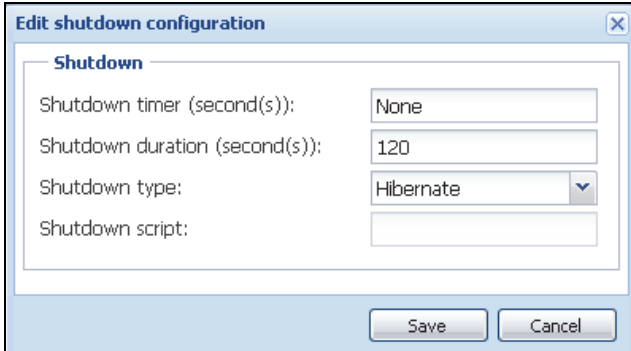

Figure 18. Edit Shutdown Configuration Dialog Box

Shutdown Timer [Optional]

This is the time period from mains power failure until the launch of the UPS shutdown sequence.

Shutdown Duration

This is the time taken from the “Shutdown now” command to when the computer has completed the shutdown process.

Shutdown Type

If Hibernate (default option) is available with your operating system, is better to use the hibernation feature (first available with Windows 2000) because there are a number of advantages. If the system is shut down, all work in progress and system information is automatically saved to the disk. The computer is also de-energized. When mains power returns, all the applications re-open exactly as they were and the user is returned to their work environment.

The Hibernate function must first have been activated in the operating system. In the power options on the Windows control panel, check that hibernate option is activated on the Hibernate tab sheet.

NOTE: If you select hibernate, but your computer does not have this function, Dell ULNM will still protect the installation by carrying out the normal (default) shutdown. If restart conditions are the same, then shutdown, refer to BIOS computer configuration. For Windows Vista, refer to the Troubleshooting section of this manual.

Shutdown

This option shuts down your applications and the system, but does not de-energize the computer. The system offers the user the choice to de-energize the computer, in which case, it is the UPS that powers on most computers, this configuration is necessary if you want the server to restart as soon as mains power returns.

Power-off

This option shuts down your applications and the system, and de-energizes the computer. This configuration is advised if you wish to be on hand when the system restarts, or for load shedding.

Script

This option manages the shutdown in a custom script that you can use to create your own shutdown sequence. You can integrate the standard Windows shutdown command

NOTE: Find more information with `shutdown /?` in a Windows Command Line shell. Shutdown script: the absolute path of the script.

Outlet Shutoff Active

Using this option, Dell UPS Local Node Manager will send a delayed shutoff command to the outlet. This delayed command is sent to the UPS at the beginning of the shutdown sequence, and this is the point of no return for the shutdown sequence. The UPS outlet is turned off at the end of the shutdown sequence.

Shutdown Sequence Trigger

When a power utility failure occurs, the shutdown sequence is started as soon as the first of the two following condition is reached:

- After the Shutdown timer (if configured) is reached.
- When Dell Network Management Card or UPS shutdown criteria is reached. This decision is according to many criteria, as shown in Figure 19.

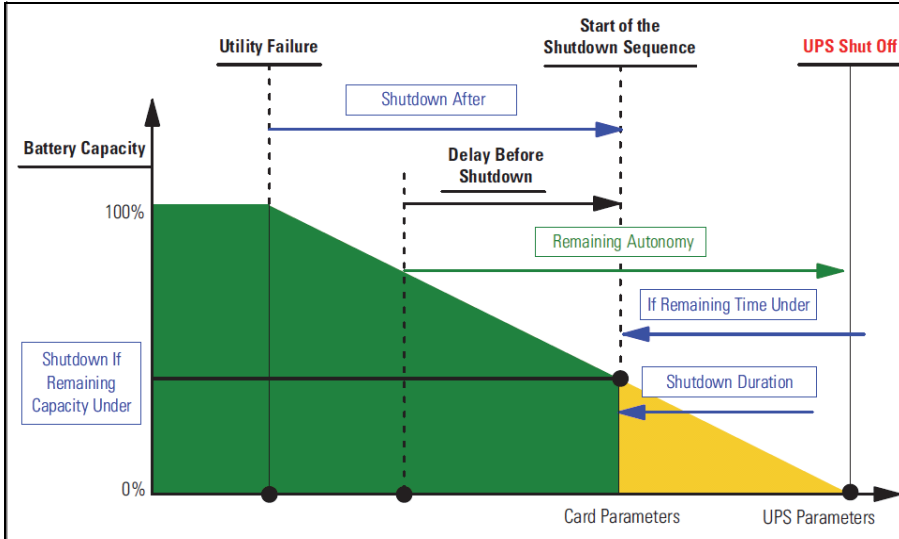

Figure 19. Shutdown Sequence

Edit Advanced Shutdown Criteria

To edit advanced shutdown criteria:

- 1 Login with an administrator user profile.
- 2 Select **Settings > Shutdown**. The Shutdown page is displayed.
- 3 Click **Edit advanced shutdown criteria**. The Edit Advanced Shutdown Criteria dialog box displays (see Figure 20).
- 4 Change parameters as needed.
- 5 Click **Save**.

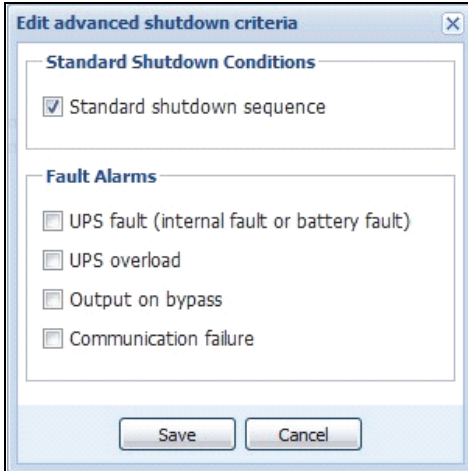

Figure 20. Edit Advanced Shutdown Criteria Dialog Box

Criteria Definition

Shutdown criteria is reached (enabled by default): This is the standard shutdown sequence taking into account “time based criteria” and “UPS low battery level criteria.”

Fault Alarms

You can also select one or several events in the following events list. If these events are selected, they will trigger an immediate shutdown in the order in which they occur:

- UPS Fault (internal fault or battery fault)
- UPS Overload
- Output on bypass
- Communication failure

NOTE: When using a Virtual Power Source (in a redundant configuration), only the following criteria can be used: Shutdown criteria is reached, Redundancy Lost, and Protection Lost.

Edit UPS Configuration

To edit the UPS configuration:

- 1 Login with an administrator user profile.
- 2 Select **Settings > Shutdown**. The Shutdown page is displayed.
- 3 Click **Edit UPS configuration**. The Edit UPS Configuration dialog box displays (see Figure 21).
- 4 Change parameters as needed.

- 5 Click Save.

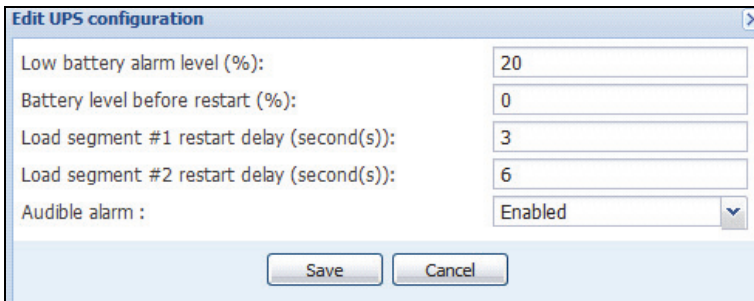

Figure 21. Edit UPS Configuration Dialog Box

The Edit UPS Configuration dialog box is available for some UPSs connected through USB or serial. Otherwise, the parameters are displayed as “read only” through the network or if the UPS does not support this feature.

You can configure following UPS parameters:

- Low Battery alarm level
- Load Segment restart delays
- Audible alarm

Test Access

Test access checks if the login and password are correctly configured so that:

- Dell ULNM can update his shutdown configuration on the card
- Dell ULNM can remotely access to the Dell ULNM Shutdown Controller

Test Shutdown

Test shutdown starts a shutdown procedure according to the Dell ULNM parameters.

WARNING: This action will launch the entire shutdown sequence, including the UPS shut off.

Shutdown Use Case

According to different architecture, we describe several typical use cases that will help you to configure properly the shutdown sequence according to your needs.

Architecture #1

This section provides shutdown use cases for a local, attached UPS through USB/Serial (see Figure 22).

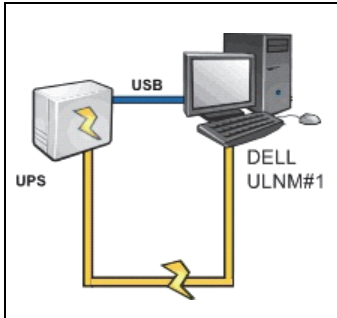

Figure 22. Architecture #1 Schema

Use Case 1

You want to keep your computer hosting Dell ULNM#1 alive as long as possible.

- This is the default Dell ULNM#1 configuration. Figure 23 illustrates this Dell ULNM default configuration available from **Settings > Shutdown > Edit Shutdown Configuration**.

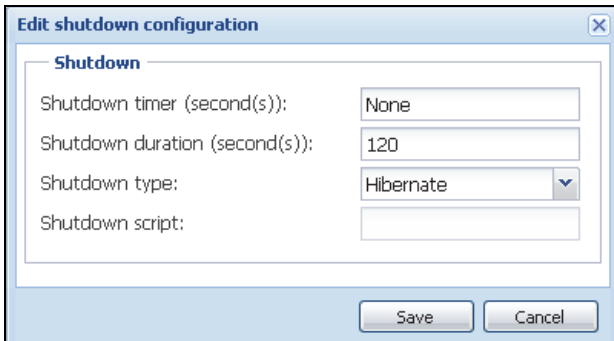

Figure 23. Edit Shutdown Configuration Dialog

Use Case 2

To save battery backup time, you want to perform load shedding. You want to stop your computer after a predefined time.

- Configure a Shutdown timer value on Dell ULNM#1. This configuration parameter is available from **Settings > Shutdown > Edit Shutdown Configuration**.

Architecture #2

This section provides shutdown use cases for a network-attached UPS through Web SNMP Card (see Figure 24).

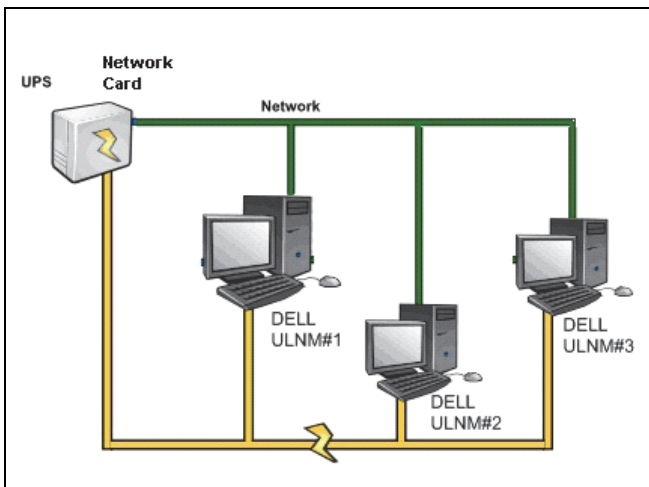

Figure 24. Architecture #2 Schema

Use Case 1

You want to keep all your computers alive as long as possible.

- This is the default configuration for the Dell ULNM and the Dell Network Management Card.
 - The Dell ULNM default configuration is available from **Settings > Shutdown > Edit Shutdown Configuration**.
 - The Dell Network Management Card default shutdown configuration is available from **UPS > Shutdown Configuration**, as illustrated in Figure 25.

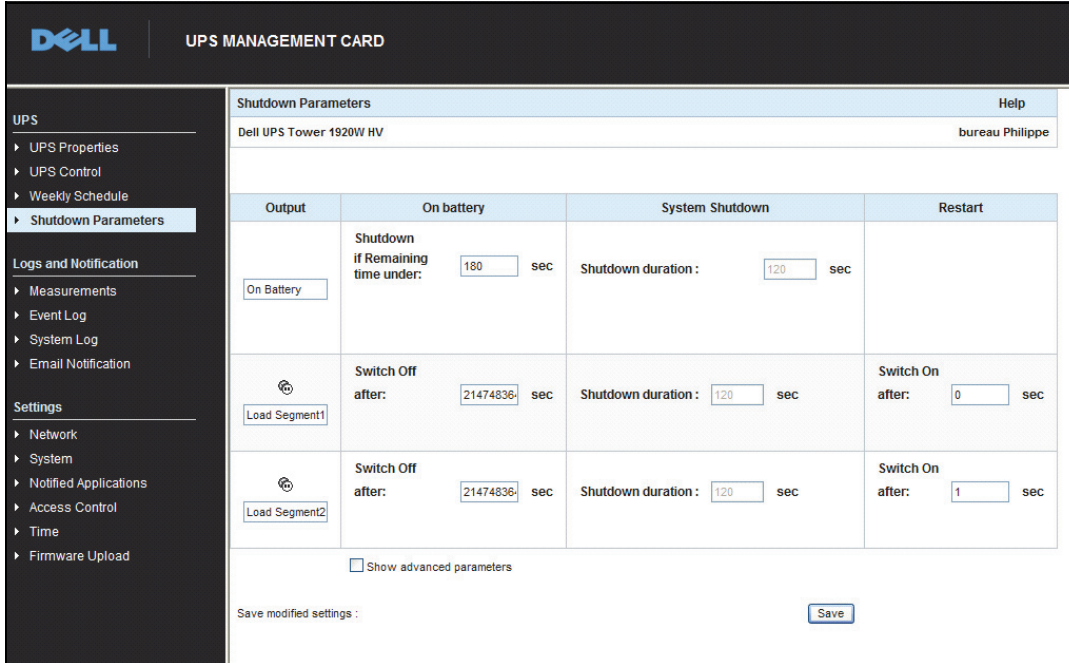

Figure 25. Dell UPS Management Card Web Interface

Use Case 2

To save battery backup time, you want to stop all your computers after a predefined time.

- On the Dell Network Management Card, configure a Shutdown Criteria.
 - The Dell Network Management Card shutdown configurations are available from **UPS > Shutdown Configuration**.

NOTE: In this case, the computer automatic restart is guaranteed.

Use Case 3

You want to perform load shedding on the specific computer hosting Dell ULNM#2. You want to stop the computer hosting Dell ULNM#2 after a predefined time.

- On Dell ULNM#2, configure a Shutdown Timer value.
 - This configuration parameter is available from **Settings > Shutdown > Edit Shutdown Configuration**.

NOTE: In this case, the automatic restart for the computer hosting Dell ULNM #2 is not guaranteed.

NOTE: Use Case 3 can be combined with Use Case 1 or Use Case 2.

Architecture #3

This section provides shutdown use cases for a network-attached UPS through Shutdown controller(see Figure 26).

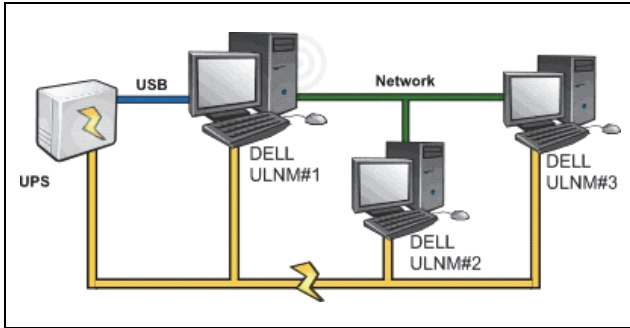

Figure 26. Shutdown Use Case - Architecture 3 Schema

Use Case 1

You want to keep all your computers alive as long as possible.

- This is the default shutdown configuration for the Shutdown Controller Dell ULNM#1 and other Dell ULNMs.
 - The Dell ULNM default configuration is available from **Settings > Shutdown > Edit Shutdown Configuration.**

Use Case 2

To save battery backup time, you want to stop all your computers after a predefined time.

- On Dell ULNM#1 (Shutdown Controller), configure a Shutdown Timer value.
 - This configuration parameter is available from **Settings > Shutdown > Edit Shutdown Configuration.**

NOTE: In this case the automatic restart for all the computers is guaranteed.

Use Case 3

You want to perform load shedding on the specific computer hosting Dell ULNM#2 (stop the computer hosting Dell ULNM#2 after a predefined time).

- On Dell ULNM#2, configure a Shutdown Timer value.
- This configuration parameter is available from **Settings > Shutdown > Edit Shutdown Configuration.**

NOTE: In this case the automatic restart for the computer hosting Dell ULNM #2 is not guaranteed.

NOTE: Use Case 3 can be combined with Use Case 1 or Use Case 2.

Use Case 4

Typical example with four computers. According to the servers' roles, you may want to shut down the servers at different times:

- Computer hosting Dell ULNM#1 is directly attached to the UPS (USB/Serial). The Shutdown Controller must be installed on the server that will be the last one to shut down.
NOTE: On Pulsar series, this computer must be powered by the master outlet.
- Computer hosting Dell ULNM#2 requires a long delay to shutdown, such as hosting database or VMware.
- Computer hosting Dell ULNM#3 must be the last one to be shutdown because other servers depend on it, such as File server.
- Computer hosting Dell ULNM#4 is another server that must be stopped before computer 2 or 3 (Web server), or this computer can also be stopped for load shedding purposes (workstation).

The recommended configurations are:

- On Dell ULNM#1: Configure Shutdown Timer to None and Shutdown Duration to 120s.
- On Dell ULNM#2: Configure Shutdown Timer to 180s and Shutdown Duration to 180s.
- On Dell ULNM#3: Configure Shutdown Timer to None and Shutdown Duration to 120s.
- On Dell ULNM#4: Configure Shutdown Timer to 120s and Shutdown Duration to 120s.

The following time diagram summarizes this configuration (see Figure 27):

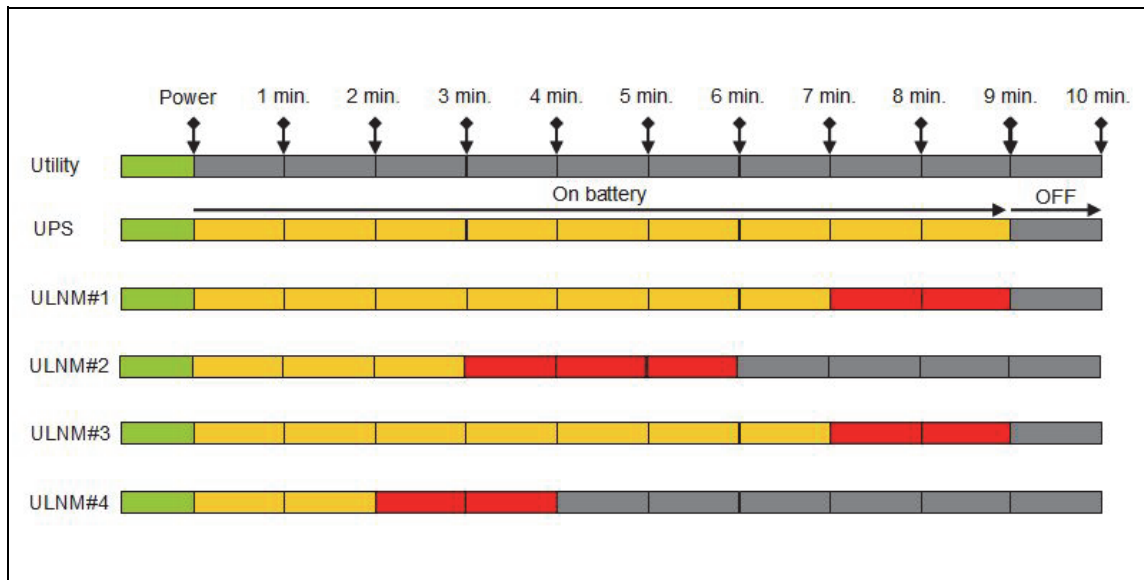

Figure 27. Shutdown Controller Diagram

Configure Actions

You can define the way users will be notified when node events happen.

From the **Settings > Actions** menu item, the following actions can be configured (see Figure 28):

- Email
- Execute script/program
- Notification to the local alarm notification box, available from the System Tray icon

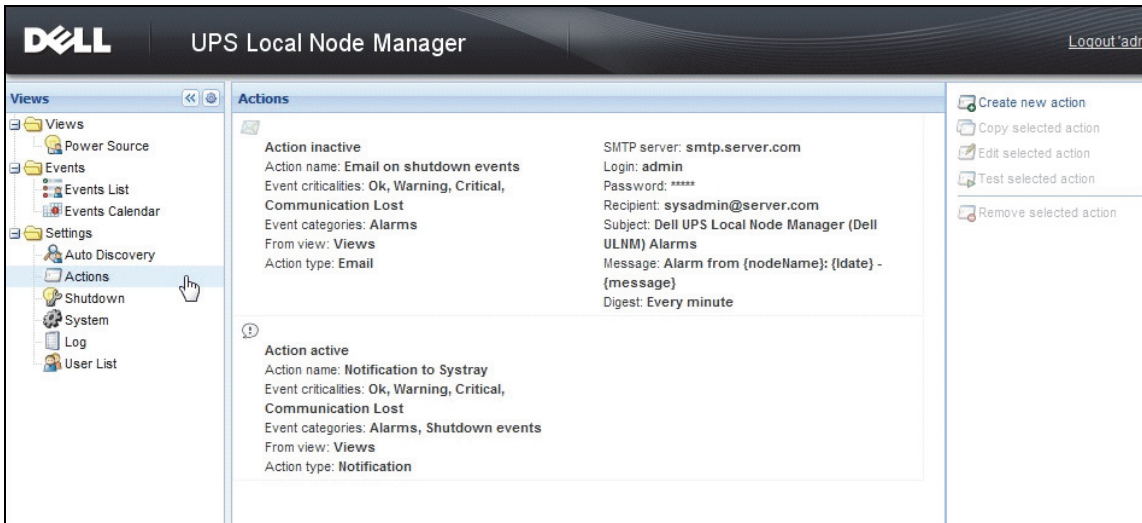

Figure 28. Actions Page

Create a New Action

To create a new action:

- 1 Login with an administrator user profile.
- 2 Select **Settings > Actions**. The Actions page is displayed.
- 3 Click **Create new action**. The Create New Action dialog box displays (see Figure 29).

Figure 29. Create New Action Dialog Box

NOTE: The "*" fields are required.

NOTE: Clicking on the pen icon starts an assistant to fill the field.

Create New Action Field Descriptions

- **Action active:** Enables/disables the action
- **Action name:** User friendly name for the action
- **Events Filter**

You can filter the action according to:

- **Event criticalities:** Critical, Warning, Normal, Communication Lost

NOTE: With this parameter, you can filter the notification according to the event level. Refer to the event category list. If you select “Critical” as filter you will not receive the associated “Normal” event informing that the device status changes from “Critical” to “Normal.”

- **Event category:** Alarms, Shutdown events, Power events, Measures) as follows:

- Alarms Event Category
 - Utility failure
 - Communication lost
 - Shutdown Imminent
 - Battery Low
 - Internal Failure
 - Overload
 - Output On/Off
 - Outlets On/Off
 - Battery Fault
 - On Automatic Bypass
 - On Manual Bypass
 - Redundancy Lost
 - Protection Lost
- Shutdown Events Event Category
 - Utility failure
 - Battery Low
 - Shutdown Imminent
 - Local Run Time to Shutdown
- Power Events Event Category
 - Output Percent Load
 - Output Apparent Power
 - Output Active Power
 - Output Power Factor
 - System Defined Output Overload Alarm
- Measures Event Category
 - Output Percent Load

- Battery Remaining Capacity
 - Battery Run Time to Empty
 - Main 1: Voltage, Current and Frequency
 - Main 2: Voltage, Current and Frequency
 - Output: Voltage, Current and Frequency
 - Output Apparent Power
 - Output Active Power
 - Output Power Factor
- **From View:** The view that triggers the event.
 - **Action type:** Email / Command / Notification
 - According to your choice, specific settings are available for each action as detailed in the following sections.

E-mail Action Type

This action is not active by default. Some of the fields are preconfigured by default. This is activated by selecting Email from the **Action type** drop-down list (see Figure 30).

The screenshot shows the 'Edit action' dialog box with the following configuration:

- Action active*:**
- Action name*:** Email on shutdown events
- Event criticalities*:**
- Event categories*:** Alarms
- From view*:** All Views
- Action type*:** Email

Settings

- SMTP server*:** smtp.server.com
- Login:** admin
- Password:** •••••
- Recipient*:** sysadmin@server.com
- Sender:** Computer 2
- Subject:** Intelligent Power Protector (IPP) Alarms
- Message:** Alarm from {nodeName}: {ldate} - {message}
- Digest*:** Every minute

Buttons: Save, Cancel

Figure 30. Email Action Type Settings

SMTP Server: To receive email on UPS events you must indicate the SMTP server IP address

- **Login and Password:** Authentication information of the SMTP server
- **Recipient:** Receiver email address

NOTE: You can specify multiple receivers by separating them with coma.

- **Sender (Optional field):** Email sender

NOTE: Your SMTP server may require a valid email address.

- **Subject:** Email subject (can be customized with pre-defined variables)
- **Message:** Email message body (can be customized with pre-defined variables; see Editing Messages that follows)
- **Digest:** Email report that includes a consolidation of the alarms that occurred during a delay
For example, if you specify none, each alarm will generate an e-mail. Possible values are: None / Every 10 seconds / Every minutes / Every hour / Every day

Editing Messages

It is possible to duplicate an existing action already configured and then modify some of the parameters.

- For advanced use, you can Customize the Subject and Message. For example, you may choose to translate an e-mail into an SMS (Short Message Service gateway) using an email to SMS external provider.
- Click the pen icon to start the Edit message assistant to fill the field with some variables.
- Click the “plus”  button to add a variable (see Figure 31).

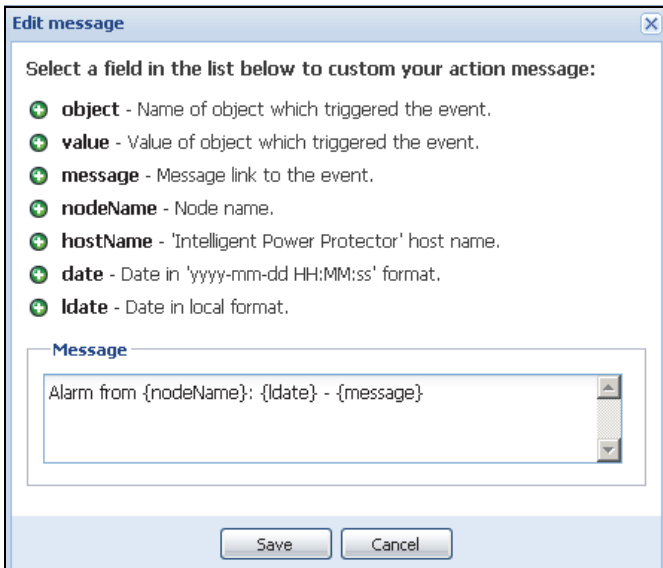

Figure 31. Edit Message Dialog Box

Command Action Type

The Command Action type executes a script or program (see Figure 32). In order to execute a program on UPS events, the program path is required.

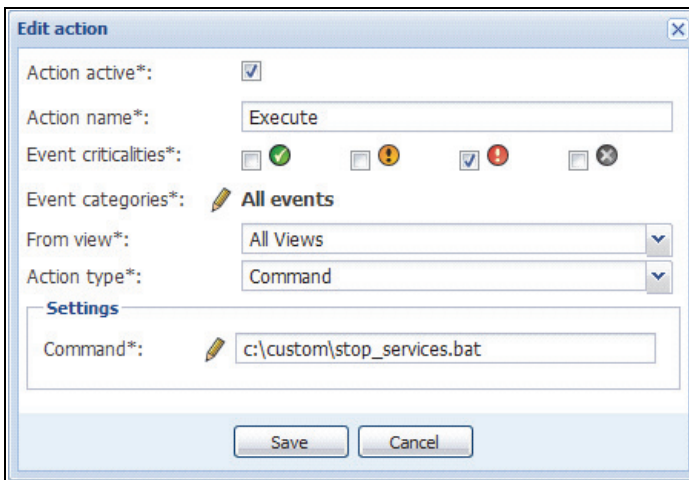

Figure 32. Command Action Type Settings

Here is an example to play sound alarms on events:

- 1 Create a batch command file containing the command:
`mplay32.exe /play /close C:/WINDOWS/Media/<sound>.wav`
- 2 Create an action of type command calling this batch file.

Windows

For Windows, the program is executed under the SYSTEM account. For the correct execution of some privileged commands, you may have to apply the following procedure:

- It may be necessary to modify the context before certain actions can be run.
- To allow a user to run specific tools and programs with permissions that are different from those assigned to the user's account, use the Windows “RunAs” command, which allows you to save the password (Windows XP Service Pac 2 and more recent versions).
- Use the following Microsoft command:
`runas /profile /user:<my login> /savecred <my_program.exe>`
- On first execution, a password is required. It is saved for subsequent executions.

Linux

For Linux, the Dell ULNM process is running under root privilege (sudo command is not needed to execute a program or shell script).

Notification Action Type

The Notification action (alarm box notification) is active by default (see Figure 33).

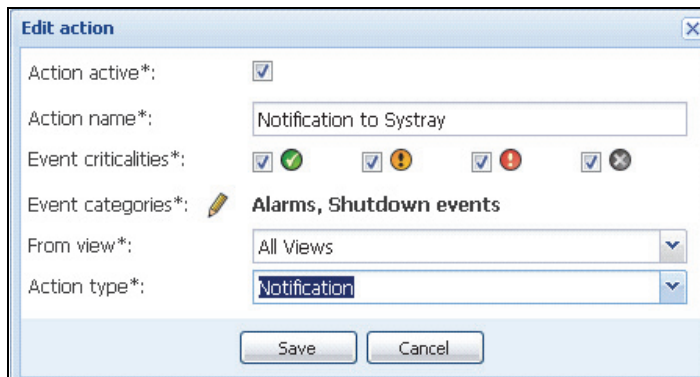

Figure 33. Notification Action Type Settings

The alarms are displayed on the local computer in an alarm box. This alarm box displays the last 10 alarms. It takes the focus when a new alarm occurs. From the event section, you can view more than 10 alarms (see Figure 34).

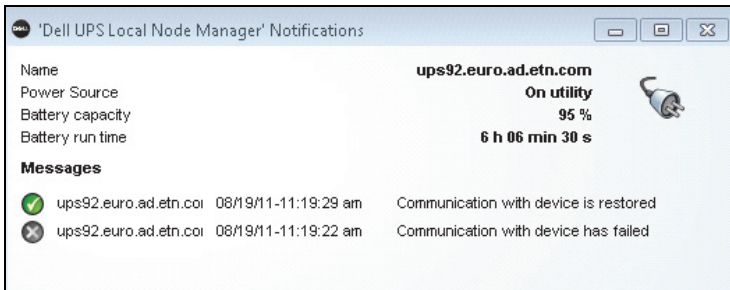

Figure 34. Alarm Notification Box

Use the System Tray icon to perform the following:

- Double-click the System Tray icon to open the window that displays the alarms on the local computer.
- Right-click the System Tray icon to provide fast access to the functions shown in Figure 35.

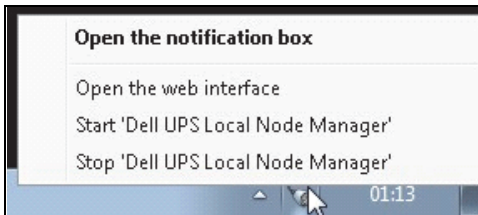

Figure 35. Systray Box Menu

If a Power Source has been declared, the System Tray Icon can have the states described in Table 6.

Table 6. System Tray State Icons





Icon	State Description
	The System Tray Icon correctly receives alarms from Dell UPS Local Node Manager. AC is present on the Power Source.
	The System Tray Icon correctly receives alarms from Dell UPS Local Node Manager. The Power Source runs in battery mode.
	The System Tray Icon correctly receives alarms from Dell UPS Local Node Manager. A Warning event occurred on Power Source.
	The System Tray Icon correctly receives alarms from Dell UPS Local Node Manager. A critical event occurred on Power Source.

Table 6. System Tray State Icons

Icon	State Description
	Communication with Power Source has failed.

Advanced Events and Actions Customization

In the Dell ULNM installation folder, there is a configs/scripts folder containing a sample user-defined action script (***sample_user_script.js***).

You can modify this script or create new scripts that define very specific events and actions. The sample script provides details about the expected structure and syntax for defining new actions and triggers.

To activate the execution of a script, set the enabled property to true as follows:

```
UserScript =  
{  
  name: "MyScript",  
  enabled: true, // Set this property to true to enable the script  
}
```

Configure User Accounts

To configure multiple user accounts:

- 1 Login with an administrator user profile.
- 2 Select **Settings > User List**. The User List page is displayed (see Figure 36).
- 3 Click Add user.
- 4 Type the user's login and the user's password.
- 5 Select the user's profile level. The following levels are available:
 - admin (the user will be able to access all the features)
 - user (the user will only access the visualization and cannot set changes to the system or nodes).
- 6 Click Create new user.

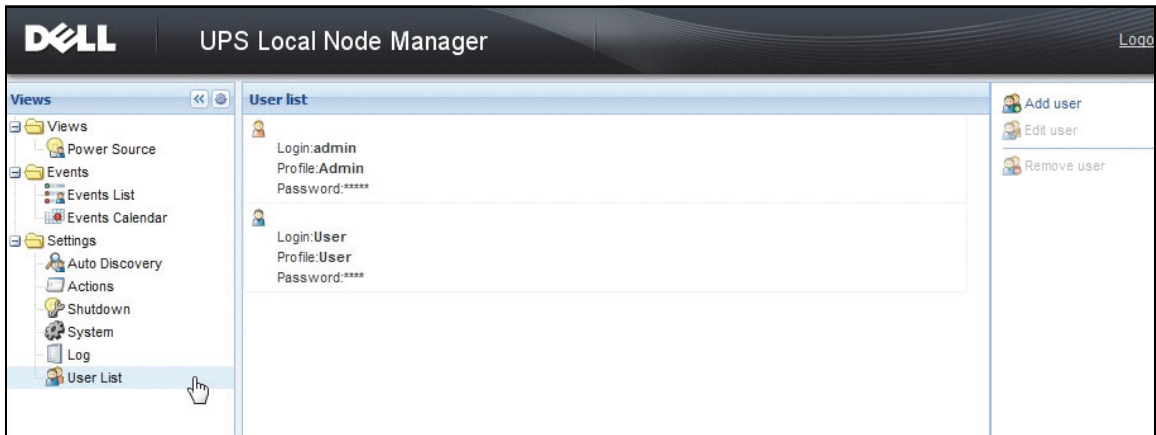

Figure 36. User List Page

Administrator Profile

The Dell ULNM contains a default Administrator profile with:

- “admin” as login
- “admin” as password

WARNING: For security reasons, it is strongly recommended that you change the default password immediately after the installation. A Popup provides a security warning if the password contains less than 8 characters.

NOTE: The login and password are case sensitive.

NOTE: The original admin account login value is fixed (admin) and its password must be modified.

NOTE: There is no limit to the number of accounts that can be created.

System Settings

You can edit system settings. From the **Settings > System** menu item, you can edit system information, edit language, edit scan settings, and edit module settings (see Figure 37).

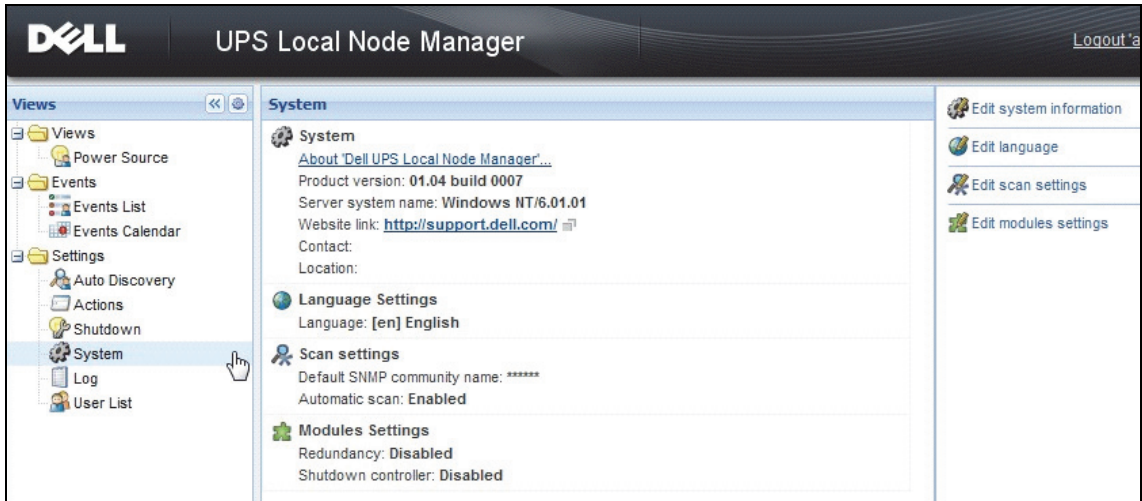

Figure 37. System Settings Page

Edit System Information

Edit system information allows the you to enter contact and location information for Dell ULNM software.

Edit Language

Edit language allows you to change the language that displays. Czech, English, French, German, Japanese, Korean, Polish, Portuguese, Russian, Simplified Chinese, Traditional Chinese, and Spanish are currently supported. It also allows you to change the date and time format and the temperature unit (Celsius or Fahrenheit).

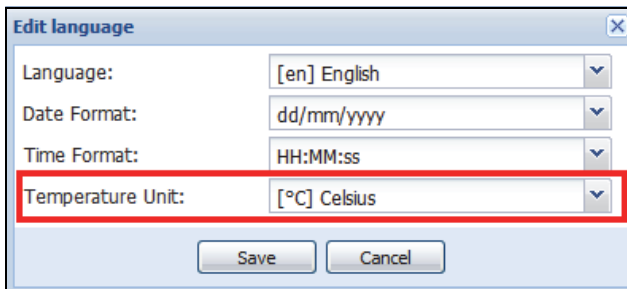

Figure 38. Edit Language

Edit Scan Settings

Administrators can set scanner authentication parameter settings that will be used as the default when discovering new devices. These authentication settings can be set for the XML, SNMPv1, SNMPv3 and NUT protocols.

When discovered, manually or automatically, newly discovered devices will use these authentication parameters. Depending on the device-supported protocols, ULNM will choose the needed parameters. See Compatibility on page 10 to determine which protocols are supported. Default scan settings are displayed in the Scan settings section of the System page (see Figure 37).

The administrator can activate the automatic scanner to add any automatically discovered devices without a direct scan action of the administrator. For example, with automatic scan enabled, the presence of a new card on the network would be auto-discovered and added.

The administrator can also activate protocols used by the scanner function by toggling protocol checkboxes (see Figure 39).

The screenshot shows a dialog box titled "Edit scan settings". It has a close button in the top right corner. The dialog is organized into several sections, each with a checked checkbox on the left:

- Automatic scan:** A checked checkbox.
- XML:** A checked checkbox. Below it are two text input fields: "Username:" containing "admin" and "Password:" containing masked characters (*****).
- SNMPv1:** A checked checkbox. Below it is a text input field: "SNMP community name:" containing "public".
- SNMPv3:** A checked checkbox. Below it are several fields: "Username:" containing "readuser", "Security level:" a dropdown menu set to "Authentication and encryption", "Authentication method:" a dropdown menu set to "MD5", "Authentication password:" a text input field with masked characters (*****), "Encryption method:" a dropdown menu set to "DES", and "Encryption password:" a text input field with masked characters (*****).
- NUT:** A checked checkbox. Below it is the text "No specific authentication parameter".

At the bottom of the dialog are two buttons: "Save" and "Cancel".

Figure 39. Edit Scan Settings

Configure Node Settings

An administrator can configure node information and access parameters using the **Settings > Auto Discovery** menu item selection. The Nodes List page displays. Click the Edit node information button or click the Set node access parameters button in the right panel.

- **Edit node information dialog.** The Edit node information dialog box allows editing the node name, the user type, the node description and the associated load alarm threshold (see Figure 40).
- **Access parameters dialog.** You can define the way users will be notified when node events happen and edit authentication settings for all selected devices. Only relevant settings are set, depending on the capabilities of the selected device (see Figure 41).



Figure 40. Edit Node Information Dialog

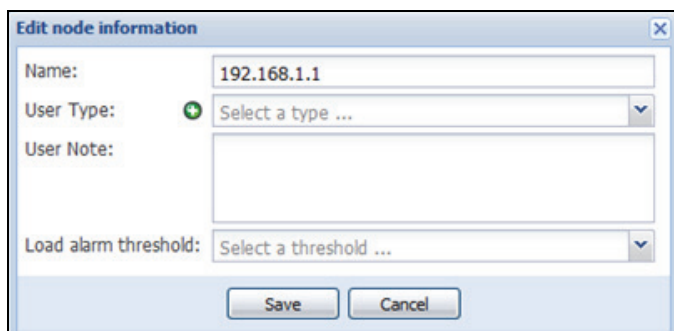

Figure 41. Access Parameters Dialog

Edit Update Settings

Edit update settings allows you to customize the Automatic Updates Feature that gives you access to Dell software updates.

NOTE: Dell ULNM will always be up-to-date if you select the “Check automatically” option. When a new software version is detected on the Dell Web site, follow the wizard instructions.

- Dell ULNM settings will be retained with this operation.
- Dell ULNM can manage updates with large number of computers.

Check for Updates

The Check for updates option checks if a more recent version of the product is available on the Dell Web site.



Edit Module Settings

Edit module settings enables optional modules, such as the Shutdown Controller.

Shutdown Controller

The Dell ULNM can acquire UPS alarms from a UPS (through USB or RS-232) and forward the shutdown alarms to the other Dell ULNMs. This specific Dell ULNM is called the “Shutdown Controller.” The Shutdown Controller can acquire information through a Dell Network Management Card.

You must activate the Shutdown Controller feature on the Dell ULNM that relays the alarms (connected to the UPS through USB or RS-232).

NOTE: The Notified Applications list is persistent. The status of this remote ULNM will change from OK (green ) to Communication Lost (gray ) if you uninstall a remote ULNM or if there is a communication lost event between the shutdown controller IPP and the remote ULNM. With this mechanism the IT administrator will be able to monitor any change in the IT distributed architecture. You can manually remove the ULNMs from this list through the ***Auto Discovery > Remove Nodes***.

To activate the shutdown controller feature:

- 1 Login with an administrator user profile.
- 2 Select **Settings > System**. The Systems page is displayed.
- 3 On the System page, double-click **Module settings** (see Figure 42). The Edit Modules Settings dialog box is displayed.
- 4 Check the **Shutdown Controller** check box (see Figure 43).

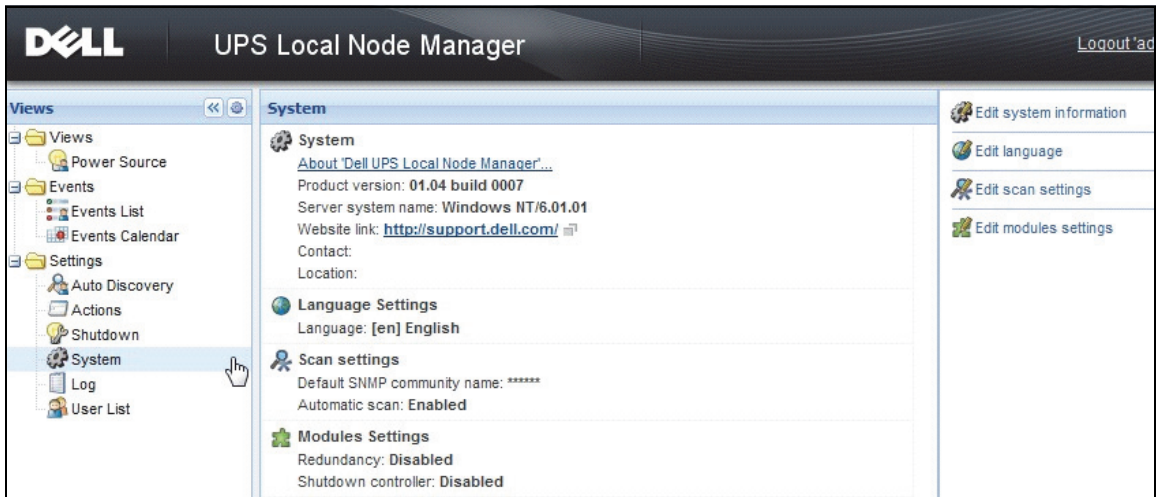

Figure 42. Module Settings Selection

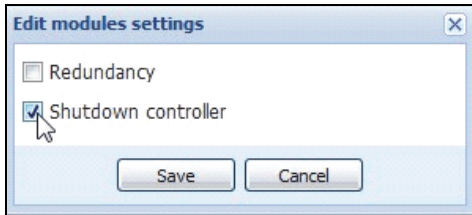

Figure 43. Enable Shutdown Controller

When this feature is activated on a Dell ULNM, a new view called “Notified Applications” will appear in the menu of the Shutdown Controller of the Dell ULNM and the top banner will be updated, as shown in Figure 44.

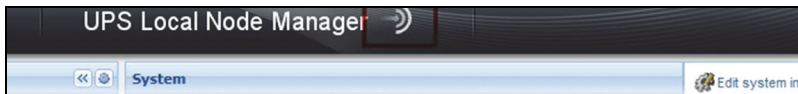

Figure 44. Banner Change for Shutdown Controller

Configure Parameters for Other Dell ULNMs

Other Dell ULNM's will discover this Dell ULNM through a network scan.

From these other Dell ULNMs, configure the parameters in **Setting > Shutdown > Configuration**.

The main parameters are:

- Power Source (indicate the IP address of Dell ULNM#1 that is the Shutdown Controller)
- Load Segment
- Login and Password (You must use “admin” account)

Click **Save** when you enter all parameters.

Now this Dell ULNM is registered in the “Notified Applications” view of the Shutdown Controller (see “Notified Applications View” on page 62).

Example with 3 computers

NOTE: Refer to the Shutdown Use Cases for Architecture #3 on page 44.

A UPS is locally connected (through USB) to computer 1 hosting Dell ULNM #1 (Shutdown Controller role):

- The Dell ULNM #1 automatically detects its UPS.
- You must activate the “Shutdown Controller” feature for Dell ULNM #1.
- In Dell ULNM #2 interface, you must indicate the IP address of Dell ULNM #1 computer, the load segment, and Dell ULNM #1 Login and Password.
- In Dell ULNM #3 interface, you must indicate the IP address of Dell ULNM #1 computer, the load segment, and Dell ULNM #1 Login /Password.
- Dell ULNM #1 will forward Shutdown alarms to remote Dell ULNM instances (Dell ULNM #2 and Dell ULNM #3).
- As a consequence, the three servers powered by this UPS are protected.

Figure 45 provides a corresponding power flow view where one UPS powers three single-feed servers:

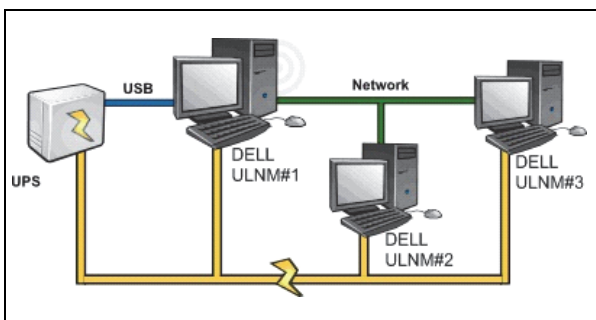

Figure 45. Power Flow View

Notified Applications View

The “Notified Applications” view will appear in the Node List page when the Shutdown Controller feature is activated. When you select a line, the right-hand panels will be refreshed according to the selection (see Figure 46).

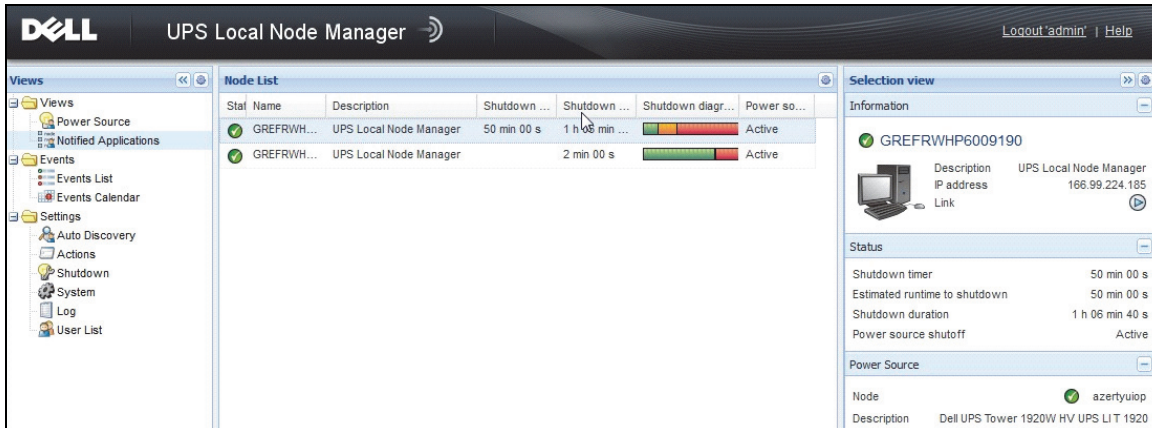





Figure 46. Notified Applications View

The following notes apply to the Notified Applications view:

- The “Notified Applications” list is persistent.
- The status of this remote Dell ULNM will change from OK  to Communication Lost  if you uninstall a remote Dell ULNM or if there is a communication lost event between the shutdown controller Dell ULNM and the remote Dell ULNM. With this mechanism, the IT administrator can monitor any change in the IT distributed architecture.
- You can manually remove the Dell ULNM products from this list through the **Auto Discovery > Remove Nodes**.

Status Icons

- The green icon  indicates that communication is OK between Local and Remote Dell ULNM.
- The grey icon  indicates that communication is lost between Local and Remote Dell ULNM.

Shutdown Diagram

The shutdown diagram is a time illustration of the shutdown sequence of the selected computer. It presents a visual representation of the shutdown sequencing between the different computers (see Figure 47).



Figure 47. Shutdown Diagram

- The total width is the remaining runtime to empty of the power source (in case a power failure would happen or is in progress).
- The green segment represents the duration the computer is running on UPS battery.
- The orange segment represents the computer shutdown duration.
- The red segment represents the duration the computer is off, but the UPS is still in operation.

Supervision

This chapter describes supervision features in the Dell UPS Local Node Manager (ULNM).

Access to the Monitoring Interface

To monitor the Power Source, start the main Dell ULNM interface. You can access the interface locally or remotely.

Local Access

From the system where Dell ULNM is installed, you can use the following shortcut:

- 1 Start **Program > Dell > UPS Local Node Manager** and open the Dell ULNM.
- 2 From a local machine, you can type either of the following URLs in a Web browser:
http://127.0.0.1:4679/
Or
https://127.0.0.1:4680/

Remote Access

- 1 From a remote machine, you can type either of the following URLs in a Web browser:
https://<name or IP address of computer hosting Dell ULNM>:4680/
Or
http://<name or IP address of computer hosting Dell ULNM >:4679/
- 2 In SSL mode, accept the certificate using the procedure provided by your browser.
- 3 Enter the Login and Password.

Power Source

From the **Views > Power Source** menu item, you can (see Figure 48):

- Supervise the information from the UPS that powers the Dell ULNM computer
- Drag and drop the panels

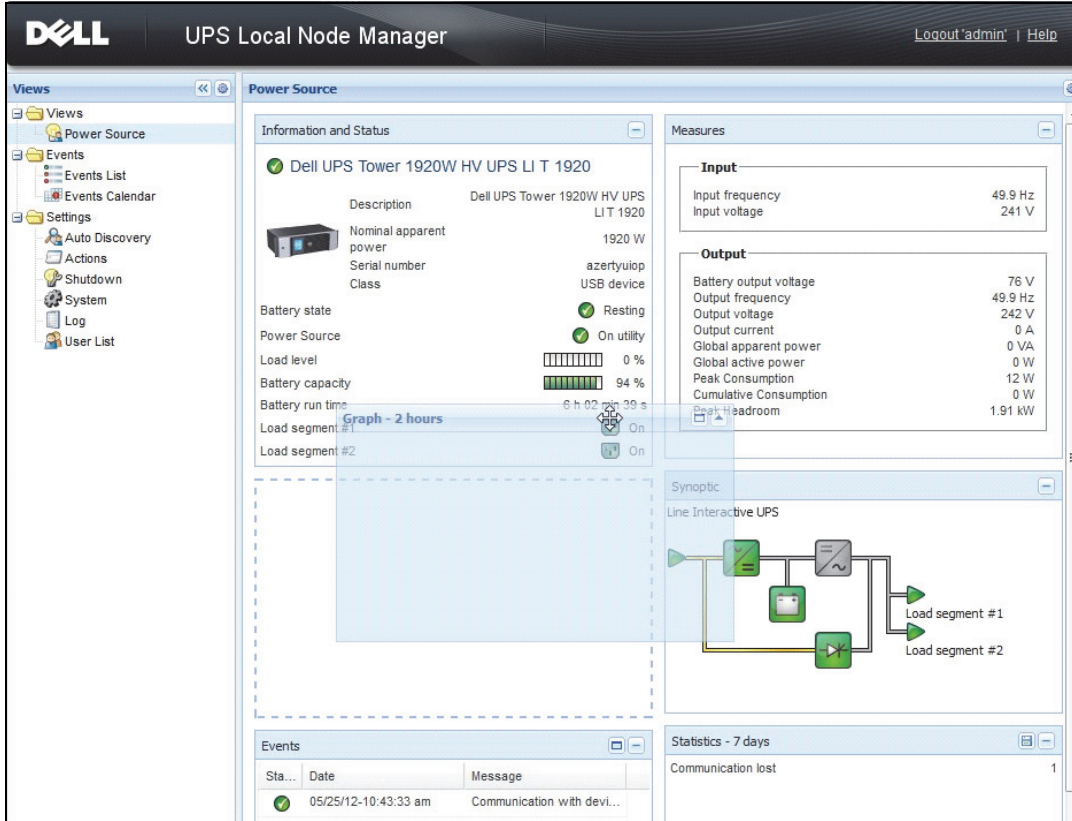





Figure 48. Drag and Drop

Flexible Panels View

To select which panels display in the view, select one of the device/applications in the list and “Detailed Panels” displays in the right side of the window.

- Click the bar title to collapse/extend the panel.
- You can also show  or hide  all the views menu or selection view menu.
- Click the selection button  to select which panels you want to add in the selection view (see Figure 49).

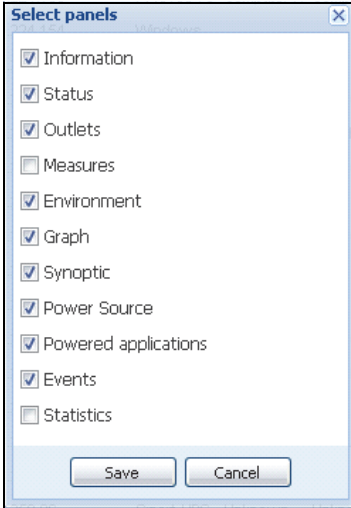

Figure 49. Panel Selection Dialog Box

NOTE: Some of the panels are only available for specific node types.

Panels List

Information and Status Panel

This panel displays information on the device that powers the server running the Dell ULNM (see Figure 50).

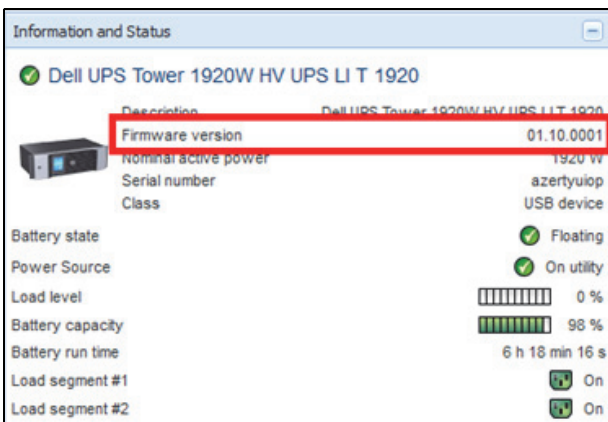

Figure 50. Information and Status Panel

The following node information is displayed in this panel:

- **Description:** Commercial product name
- **Firmware version:** Firmware revision level of the UPS or the Dell NMC card set up as power source
- **Nominal Apparent Power:** UPS Nominal Apparent Power (in Watt)
- **Serial Number:** Device Serial Number (if available)
- **Battery state:** Charging / Discharging / Default / Floating / Resting
- **Power source:** AC Power / Battery
- **Load Level:** Output load level of the device
- **Battery capacity:** Battery capacity of the device
- **Battery run time:** Thee device remaining backup time
- **Load segment 1:** Output outlet status (ON/OFF)
- **Load segment 2:** Output outlet status (ON/OFF)

NOTE: The information displayed in this panel depends on the UPS capabilities (see Figure 51).

Measures Panel

This panel displays the selected device electrical parameters for single-phase or three-phase devices, depending on the node capabilities (see Figure 51).

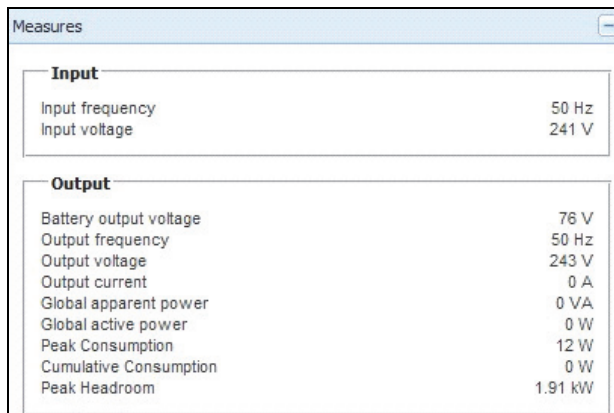

Input	
Input frequency	50 Hz
Input voltage	241 V
Output	
Battery output voltage	76 V
Output frequency	50 Hz
Output voltage	243 V
Output current	0 A
Global apparent power	0 VA
Global active power	0 W
Peak Consumption	12 W
Cumulative Consumption	0 W
Peak Headroom	1.91 kW

Figure 51. Measures Panel

The following node information is displayed in this panel:

- xxx.xxx.xxx.xxx: The DNS name (or IP address) is displayed near the "status icon"
- **Description:** The commercial product name
- **Nominal Apparent Power:** The UPS Nominal Apparent Power (in VA or KVA)

- IP address: The Web/SNMP card IP address (if network acquisition)
- Mac address: The Web/SNMP card Mac address (if network acquisition)
- Location: The device location (value of syslocation object or can also be configured in the Device page)
- Contact: The device contact (value of syscontact object or can also be configured in the Device page)
- Serial Number: The device Serial Number (if available)
- Link: Link to the device Web site (if available)
- Battery state: Charging / Discharging / Default / Floating / Resting
- Power source: AC Power / Battery
- Load Level: The output load level of the device
- Battery capacity: Battery capacity of the device
- Battery run time: The device remaining backup time
- Master Output: Main output status (ON/OFF/Internal Failure/On Automatic Bypass/Manual By Pass/Overload)
- Group #x: Output outlet status (ON/OFF)

NOTE: The information displayed in this panel depends on the UPS capabilities.

Environment Panel

This panel displays the selected device sensor information (see Figure 52):

- **Temperature sensor:** Temperature (in °C)
- **Humidity:** Humidity level
- **Input #1:** Status of first contact (open / closed)
- **Input #2:** Status of second contact (open / closed)

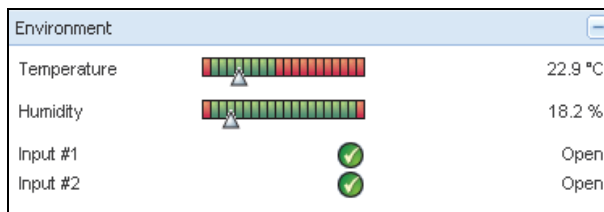

Figure 52. Environment Panel

Graph Panel



This panel displays the graph of the main measures of the selected device (see Figure 53).



Figure 53. Graph Panel

NOTE: In this window, you can select up to eight measures simultaneously. Time scale possible values are 1 hour / 2 hours / 6 hours / 12 hours / 24 hours / 2 days / 1 week.

To read the values, place your mouse cursor over the graph. A vertical line appears over it and you can read the values in the box for the selected date.

- The  button allows you to zoom in the graph and the  button allows you to export the data into the graph.
- The  button allows you to select the data you want to display in the graph (see Figure 54).

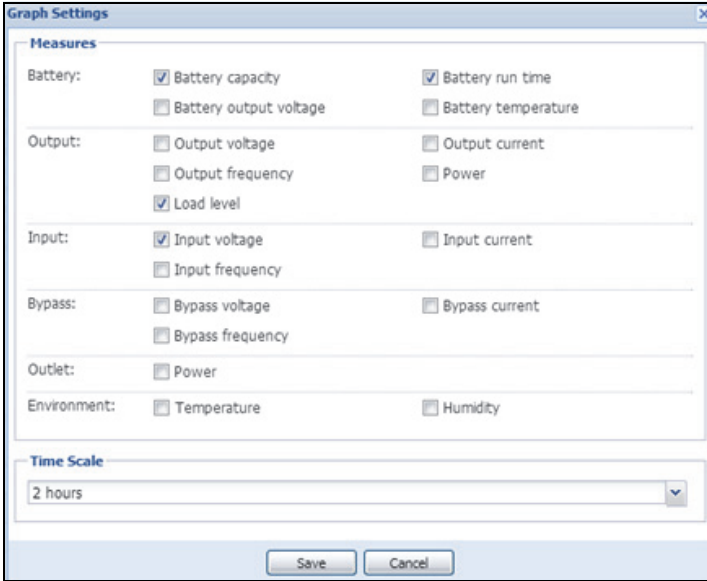



Figure 54. Graph Settings Dialog Box

To export data into a comma-separated value (CSV) file, use the Export Measures  button located in the Graph panel menu bar. The time scale chosen will apply to extracted logs.

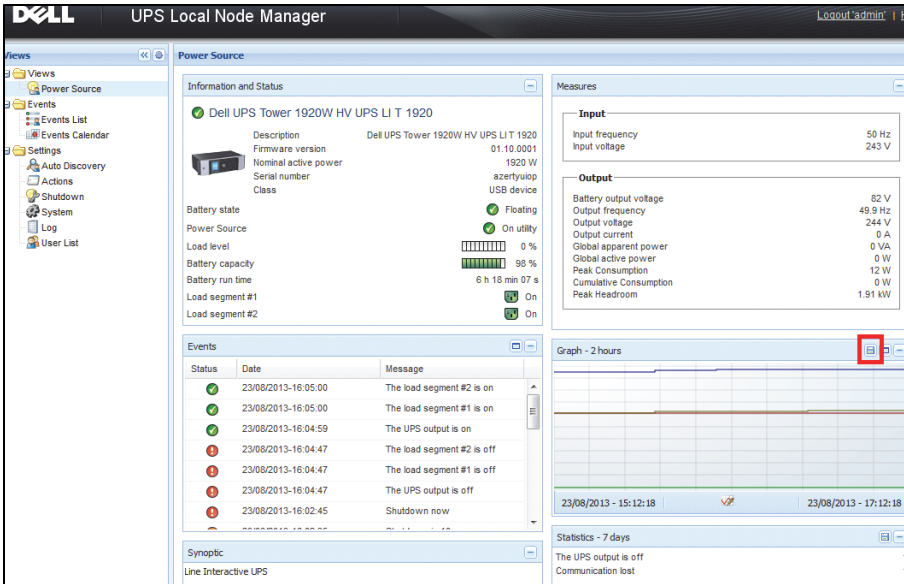

Figure 55. Export Measures Button in Graph Panel

Synoptic Panel

This panel displays the selected device synoptic (see Figure 56). In the top left corner under the banner, the UPS electrical topology is indicated, such as Online UPS, Line Interactive UPS, and so forth. A tool tip is displayed when you move the mouse over one of the functional blocks.

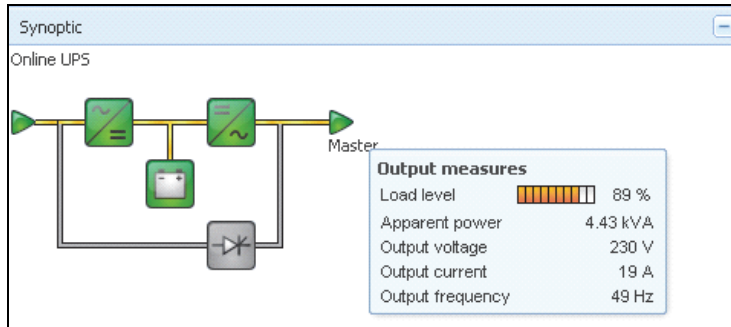

Figure 56. Synoptic Panel

The Synoptic color coded icons display for the following (see Table 7):

- UPS modules
- Battery modules
- Electrical flows
- Electrical power sources at UPS input
- Load at UPS output, with status linked to UPS output status
- Combined color codes

Table 7. Synoptic Panel Icons



Symbol	Color	Description
UPS Modules		
	Green	Status OK and Active
	Red	Internal Fault and Inactive

Table 7. Synoptic Panel Icons

















Symbol	Color	Description
	Gray	Status OK and Inactive or Unknown
Battery Modules		
	Green	Status OK
	Orange	Battery charge is less than 50%
	Red	Battery fault or End-of-backup
	Gray	Battery status unknown
Electrical Flows		
	Yellow	Current flow through the cable NOTE: The object animation gives the direction of the current flow.
	Gray	No current flow through the cable WARNING: The cable may be under voltage.
Electrical Power Source at UPS Input		
	Green	Source powered. Status OK
	Gray	Source not powered or status unknown
Load at UPS Output		
	Green	Load powered and protected. Status OK
	Red	Load not powered

Table 7. Synoptic Panel Icons

Symbol	Color	Description
	Gray	Load status not known
Combined Color Code: Flow and Power Source Status		
	Green/Yellow	Electrical power source is powered and provides electrical flow
	Green/Gray	Electrical power source is powered and does not provide electrical flow
Combined Color Code: Flow and Load Status		
	Yellow/Green	Load powered and protected
	Gray/Red	Load not powered

Events Panel

This panel displays the events list of the selected node (see Figure 57). You can sort the events according to status, date, and message by clicking the column header.

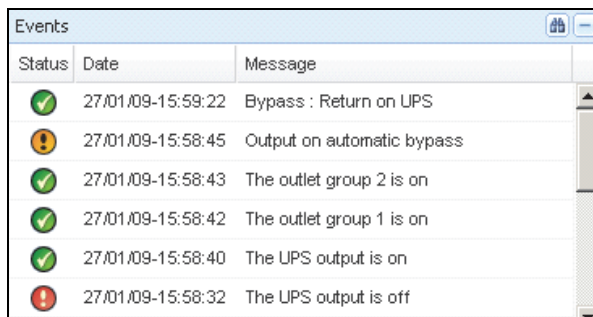







Status	Date	Message
	27/01/09-15:59:22	Bypass : Return on UPS
	27/01/09-15:58:45	Output on automatic bypass
	27/01/09-15:58:43	The outlet group 2 is on
	27/01/09-15:58:42	The outlet group 1 is on
	27/01/09-15:58:40	The UPS output is on
	27/01/09-15:58:32	The UPS output is off

Figure 57. Events Panel

Statistics Panel

This panel displays the statistics of the selected node (see Figure 58). The  button allows you to select the time interval for the statistics. You can adjust the time interval by clicking the two buttons with the “From” and “To” dates.

The statistics computed data is as follows:

- Apparent Consumption (or Active Consumption in next release, in Watts)
- Average Apparent Power (or Average Active Power in next release, in Watts)
- Power Failure Count
- Power Failure Cumulated Duration
- Battery Fault Count
- Internal Failure Count
- Overload Count
- Warning Alarm Count
- Critical Alarm CounOutput Off Count
- Communication Lost Count

NOTE: This information depends on device capabilities.

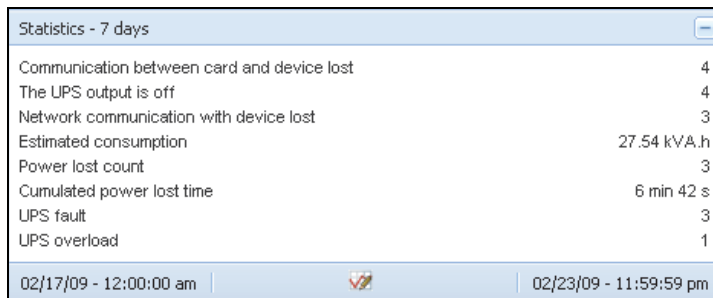

Statistics - 7 days	
Communication between card and device lost	4
The UPS output is off	4
Network communication with device lost	3
Estimated consumption	27.54 kVA.h
Power lost count	3
Cumulated power lost time	6 min 42 s
UPS fault	3
UPS overload	1

02/17/09 - 12:00:00 am |  | 02/23/09 - 11:59:59 pm

Figure 58. Statistics Panel

Events

List Representation

Select **Events > Events List** to display the Events List page (see Figure 59). All new alarms are stored in this log. You can sort the alarms according to the Status, Date, Name, Message, and Ack fields.

Status	Date	Name	Message
✓	05/15/12-1:50:11 pm	GREFRWHP60...	Communication with device is restored
✗	05/15/12-12:30:44...	GREFRWHP60...	Communication with device has failed
✓	05/11/12-4:34:12 pm	166.99.224.151	Communication failure with environment sensor
!	05/11/12-4:34:12 pm	166.99.224.151	The load segment #2 is off
!	05/11/12-4:34:12 pm	166.99.224.151	The load segment #1 is off
!	05/11/12-4:34:12 pm	166.99.224.151	The UPS output is off
✓	05/11/12-2:42:25 pm	166.99.250.118	Communication failure with environment sensor
✓	05/11/12-2:42:25 pm	166.99.250.70	Communication failure with environment sensor
✓	05/11/12-2:17:58 pm	166.99.250.114	Communication failure with environment sensor
✓	05/11/12-2:17:53 pm	166.99.250.67	Communication failure with environment sensor
✓	05/11/12-2:13:58 pm	166.99.224.171	Communication failure with environment sensor
✓	05/11/12-2:13:57 pm	166.99.224.48	Communication failure with environment sensor
!	05/11/12-2:13:57 pm	166.99.224.48	The load segment #2 is off
!	05/11/12-2:13:57 pm	166.99.224.48	The load segment #1 is off
!	05/11/12-2:13:57 pm	166.99.224.48	The UPS output is off
!	05/11/12-2:13:57 pm	166.99.224.48	The system is powered by the UPS battery
✓	05/11/12-2:13:57 pm	166.99.224.42	Sensor contact 'input #2': off
✓	05/11/12-2:13:57 pm	166.99.224.42	Sensor contact 'input #1': off
✓	05/11/12-2:13:57 pm	166.99.224.42	Communication restored with environment sensor
✓	05/11/12-2:13:57 pm	166.99.224.93	Communication failure with environment sensor
✓	05/11/12-2:13:57 pm	166.99.224.106	Communication failure with environment sensor

Figure 59. Events List Page

The following functions are available:

- **Acknowledge selected events:** Adds a check box in the Ack column for selected events
- **Acknowledge all events:** Adds a check box in the Ack column for all events

NOTE: When an alarm is acknowledged, it is marked with a check box but it is still viewable in this Event list. The acknowledged alarms disappear in the **Power Source > Event** dedicated portal panel.

- **Export Logs:** Creates a logs.csv file with the following syntax:

```
"Date", "Node", "Type", "Level", "Object", "Value", "Message",  
"2009/01/27-  
18:35:20.840", "166.99.250.83", "Measure", "0", "UPS.PowerConverter.Freq  
uency", "49", "",
```

- **Purge Logs:** Delete all logs (specify a date)
- **Select all:** Selects all displayed events
- **Deselect all:** Deselects all selected events

NOTE: You can select one alarm by clicking on it. You can also select several alarms with using shift-click or Alt-click. Selected lines appear in dark blue.

Calendar Representation

Select **Events > Events Calendar** to display the Events Calendar page (see Figure 60). In this matrix representation, each line is a week and each column is a day in the week. If you select a day or an interval (with the date-picker or using the shift+click command), the Events and Statistics panels provide all information for this selection and automatically refresh when new statistics have been computed.

The screenshot displays the Event Calendar interface. On the left is a navigation tree with categories like Views, Events, and Settings. The main area is the Events Calendar, showing a grid for the week of June 22nd to 23rd, 2010. The grid contains icons representing event severity: green for OK, yellow for Warning, and red for Critical. A selection view table on the right lists events with columns for Status, Date, Name, Message, and Ack. Below the table is a statistics panel for the selected period (June 02/10 to 06/03/10), showing metrics like Estimated consumption (8.21 kVA.h), Average apparent power (222 VA), Power lost count (18), Cumulated power lost time (2 h 09 min 20 s), The UPS output is off (5), and Communication lost (28). The bottom status bar shows overall system health: OK: 77, Warning: 20, Critical: 25, Unknown: 32, and the last event: 06/07/10 - 2:59:18 pm - PC43-Dell-Seven - Communication with device is restored.

Status	Date	Name	Message	Ack
OK	06/03/10-3...	PC43-Dell-S...	Communication with d...	
OK	06/03/10-3...	PC23-Leno...	Communication with d...	
OK	06/03/10-3...	PC22-Leno...	Communication with d...	
OK	06/03/10-3...	AV4K18007	The load segment #2 l...	
OK	06/03/10-3...	AV4K18007	The load segment #1 l...	
OK	06/03/10-3...	AV4K18007	The system is power...	
Warning	06/03/10-3...	AV4K18007	The load segment #2 l...	
Warning	06/03/10-3...	AV4K18007	The load segment #1 l...	
Warning	06/03/10-3...	AV4K18007	The UPS output is off	
Warning	06/03/10-3...	PC22-Leno...	Communication with d...	
Warning	06/03/10-3...	PC23-Leno...	Communication with d...	
Warning	06/03/10-3...	PC43-Dell-S...	Communication with d...	
Warning	06/03/10-3...	AV4K18007	The system is power...	

Statistics - 2 days - from 06/02/10 to 06/03/10	
Estimated consumption	8.21 kVA.h
Average apparent power	222 VA
Power lost count	18
Cumulated power lost time	2 h 09 min 20 s
The UPS output is off	5
Communication lost	28

Figure 60. Event Calendar Page

Nodes Events List

The icons in the different views represent the event severity.

 **NORMAL** With this event, the UPS device is returning to a normal status.

UPS Event list:

- Communication with device is restored
- Communication restored with UPS
- The system is powered by the utility
- The UPS output is on
- Communication restored with UPS
- Battery OK
- UPS returns to normal load
- UPS OK
- Bypass: Return on UPS
- End of low battery alarm
- The outlet group 1 is on
- The outlet group 2 is on
- Communication failure with environment sensor
- Communication restored with environment sensor
- Humidity is in normal range
- Temperature is in normal range
- Input #x on
- Input #x off
- End of warning alarm
- End of critical alarm
- Redundancy restored
- Protection restored

 **WARNING** A problem occurred on the UPS device. Your application is still protected.

UPS warning event list:

- The system is powered by the UPS battery
- Output on automatic bypass
- Output on manual bypass
- Humidity is below low threshold
- Humidity is above high threshold
- Temperature is below low threshold
- Temperature is above high threshold
- Warning Alarm (a generic Warning alarm is active on the device)
- The device is under its load alarm threshold
- The device is over its load alarm threshold
- Protection lost
- Redundancy lost
- Shutdown in *<time>*
- Remote Communication Error (remote communication or configuration issue is detected)

 **CRITICAL** A serious problem occurred on the UPS device. This problem requires an urgent action. Your application might NOT BE powered.



- UPS critical event list:
- The UPS output is off
- The outlet group 1 is off
- The outlet group 2 is off
- Battery fault
- UPS overload
- UPS fault
- Low battery alarm
- Applications must stop immediately...
- System shutdown in progress...
- Critical alarm (a generic Critical alarm is active on the device)

 **COMMUNICATION LOST** Communication is lost.

UPS communication event list:

- Communication failure with Device or Application

Launching Device Web Interface

From the Status panel, you can access the Web page for Dell cards, including an on-board Web server. Click the associated Web link for http access (blue icon ) or the https access (yellow icon )

Redundancy

This chapter describes the Dell UPS Local Node Manager (ULNM) redundancy features.

The Dell ULNM provides management for composite devices. Composite devices are virtual nodes composed of nodes mounted with specific redundancy schemas and a dedicated redundancy level.

NOTE: Redundant Supplies is the only composite arrangement supported in this software release.

This Redundancy feature is enabled from **Settings > System > Modules Settings** (see Figure 61).

The Dell ULNM will then shut down a local computer powered by several UPSs (composite device).

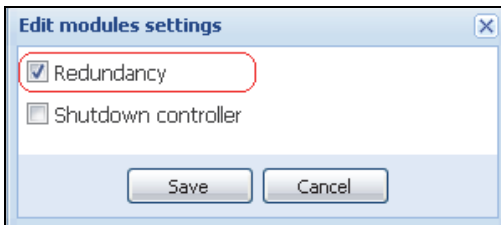

Figure 61. Edit Modules Settings Dialog Box

Figure 62 illustrates the electrical redundancy Redundant Supplies topology. In this case, the two UPSs provide power on one or several multiple feed servers.

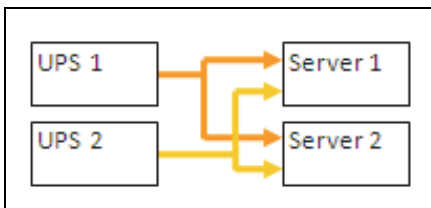

Figure 62. Redundant Supplies Redundancy Schema

Redundancy Configuration

To configure redundancy:

- 1 Login with an administrator user profile.
- 2 Select two or more nodes.
- 3 Click **Set composite device** as shown in Figure 63

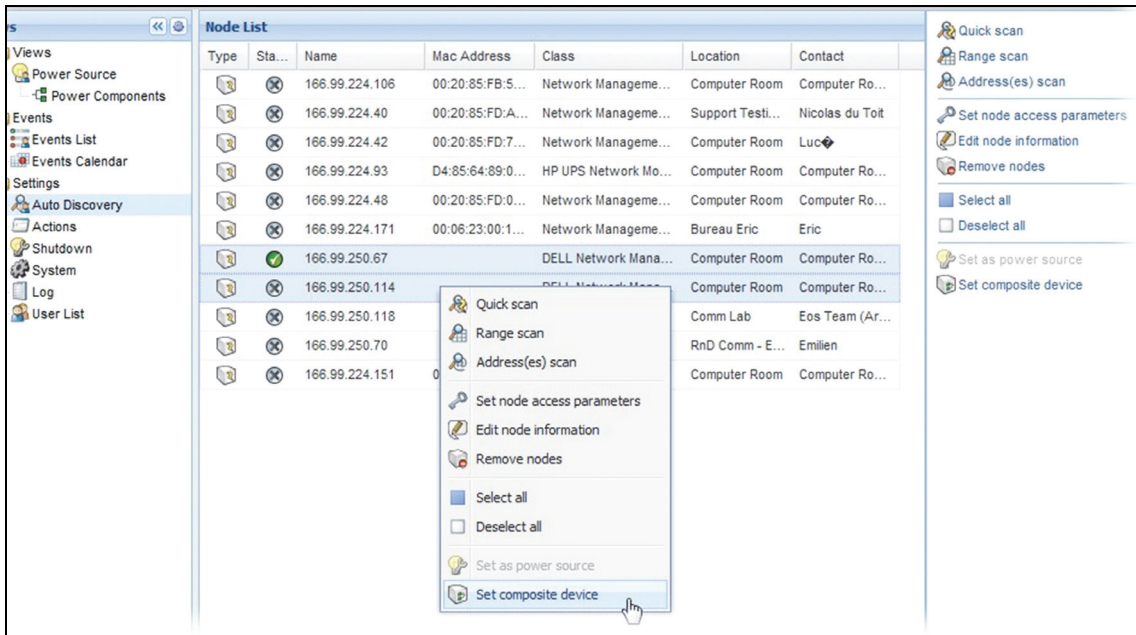

Figure 63. Selecting Set Composite Device for Nodes

- 4 In the dialog box, specify a device name and redundancy mode and level (see Figure 64):
 - **Device Name:** User name of the composite device
 - **Redundancy Level:** The minimal number of redundant UPSs powering your system. The default value is 0. For example, if you have two UPSs running in N+1 mode, type the numeral 1.

NOTE: If you set this parameter to a higher level, you will receive the “Redundancy Lost” alarm when you do not have enough redundant UPSs.

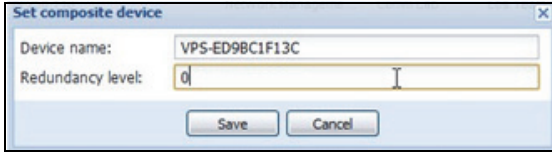

Figure 64. Set Composite Device Dialog Box

Then, the new node is created:

- You can see it in the “Autodiscovery” node list.
- You can select it as power source.
- You can edit composite device properties by selecting it in the discovery view then click again on the “Set composite device” menu item.
- If you select components of a composite device and click on the “Set composite device” menu item again, properties of existing composite device are shown; no new composite device is created so no composite device duplication is possible.

Redundancy Views

Composite Device in Power Source View

When a redundancy module is activated, a composite device can be selected as power source. The user can show it in the Power Source view.

In the Power Source view, panels are displayed with related data (see Figure 65).

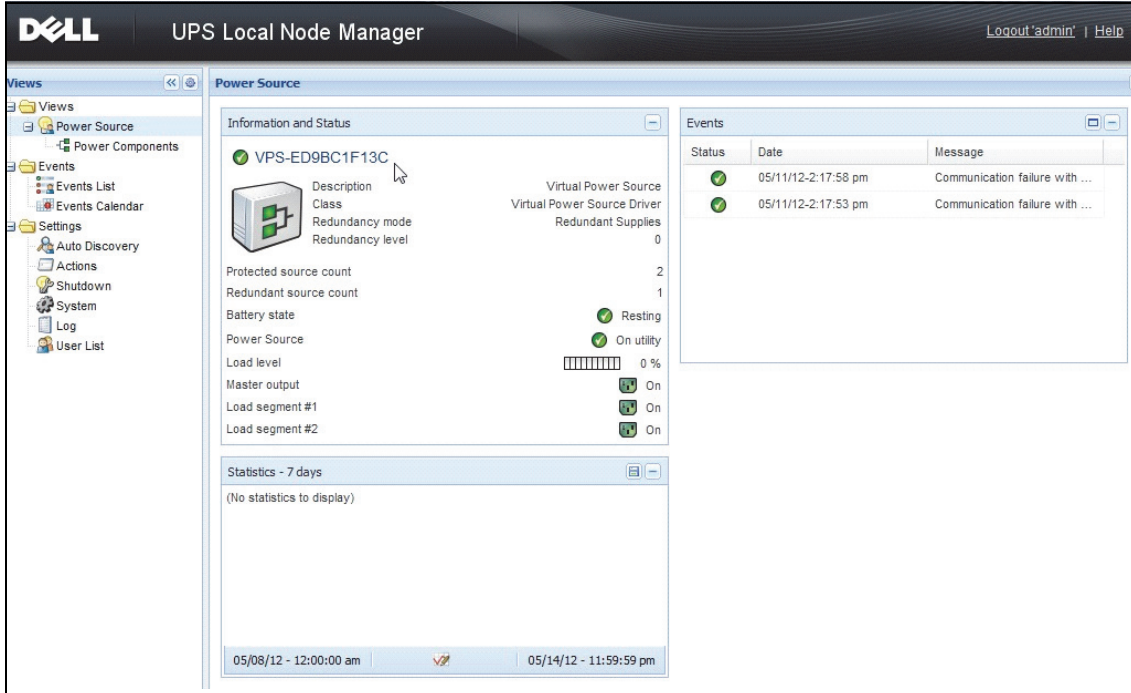

Figure 65. Composite Device Power Source View

Power Components Sub View

When a redundancy module is activated, a new power component view is available as a sub view of the Power Source view. This view shows a list of nodes with their properties (see Figure 66).

NOTE: This view shows only components of the selected power source if it is a composite device.

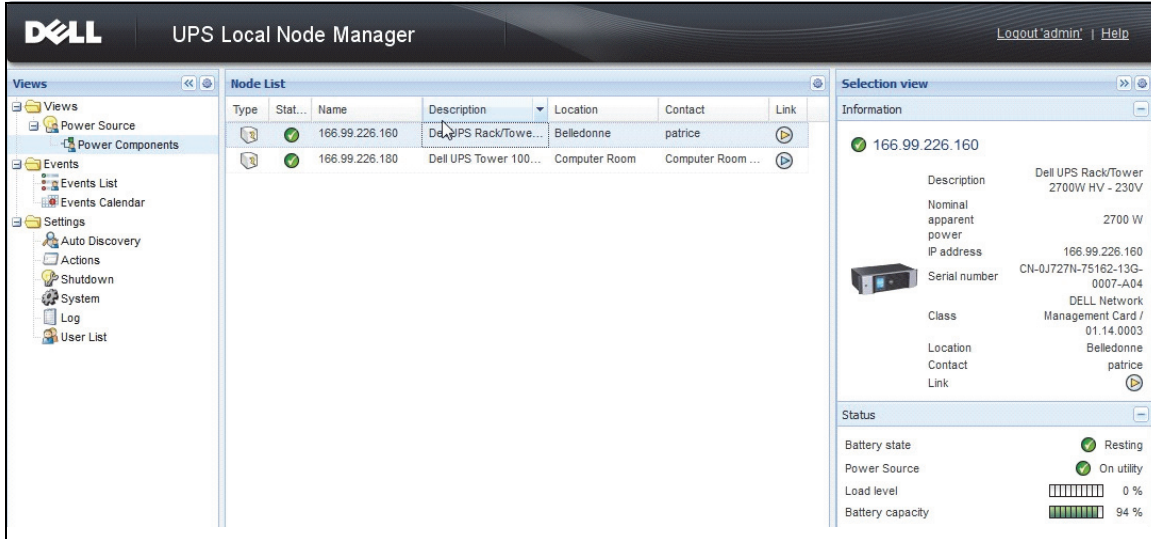

Figure 66. Power Components Sub View

Redundancy Use Cases

This section describes several typical use cases to help you properly configure the redundant shutdown sequence according to your needs.

Use Case #1

You want to have the longest backup time with the redundant configuration.

- Figure 67 illustrates the Dell ULNM default configuration available from **Settings > Shutdown > Edit Shutdown Configuration**.
- Figure 68 illustrates the Dell Network Management Card default shutdown configuration available from **UPS > Shutdown Configuration**.

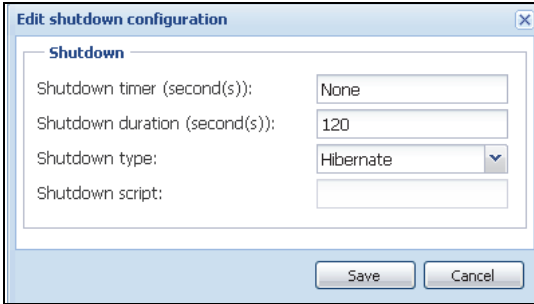

Figure 67. Edit Shutdown Configuration Dialog Box

DELL UPS MANAGEMENT CARD

UPS

- UPS Properties
- UPS Control
- Weekly Schedule
- Shutdown Parameters**

Logs and Notification

- Measurements
- Event Log
- System Log
- Email Notification

Settings

- Network
- System
- Notified Applications
- Access Control
- Time
- Firmware Upload

Shutdown Parameters Help

Dell UPS Tower 1920W HV Computer Room

Output	On battery	System Shutdown	Restart
On Battery	Shutdown if Remaining time under: 180 sec	Shutdown duration : 120 sec	
Load Segment1	Switch Off after: 600 sec	Shutdown duration : 120 sec	Switch On after: 0 sec
Load Segment2	Switch Off after: 600 sec	Shutdown duration : 120 sec	Switch On after: 1 sec

Show advanced parameters

Save modified settings : Save

Figure 68. Dell Network Management Card Web Interface

Use Case #2

You want to have a shutdown after a predefined time of 10 min. The shutdown must occur, even if only one UPS is on battery.

- In this case, each server can have its own shutdown timer (10 min, 8 min, 6 min...). To set a predefined time of 10 min, configure the shutdown timer for 10 min in the Edit Shutdown Configuration dialog box.
 - Figure 69 illustrates the Dell ULNM default configuration available from **Settings > Shutdown > Edit Shutdown Configuration**.

NOTE: This is the default configuration on the Dell Network Management Card (refer to previous use case).

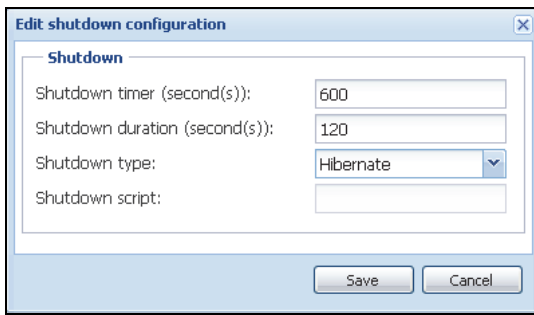

Figure 69. Edit Shutdown Configuration Dialog Box

Use Case #3

You want to start shutdown 10 min from the last detected Utility failure event. For this case, there are two UPSs, and one UPS is redundant. In addition, all servers will be shut down at the same time.

- This is the default Dell ULNM configuration. To configure this shutdown, you must set a shutdown timer of 10 min in all the Web /SNMP UPS Cards. In this case, the last UPS will send the shutdown order after 10 min if it runs on battery. If the last UPS never run on battery, the first UPS will shut down at the end of autonomy and the last UPS will take the load if it has the capacity. Otherwise, the shutdown will occur sooner.
 - Figure 70 illustrates the Dell Network Management Card Shutdown configuration available from **UPS > Shutdown Configuration**.

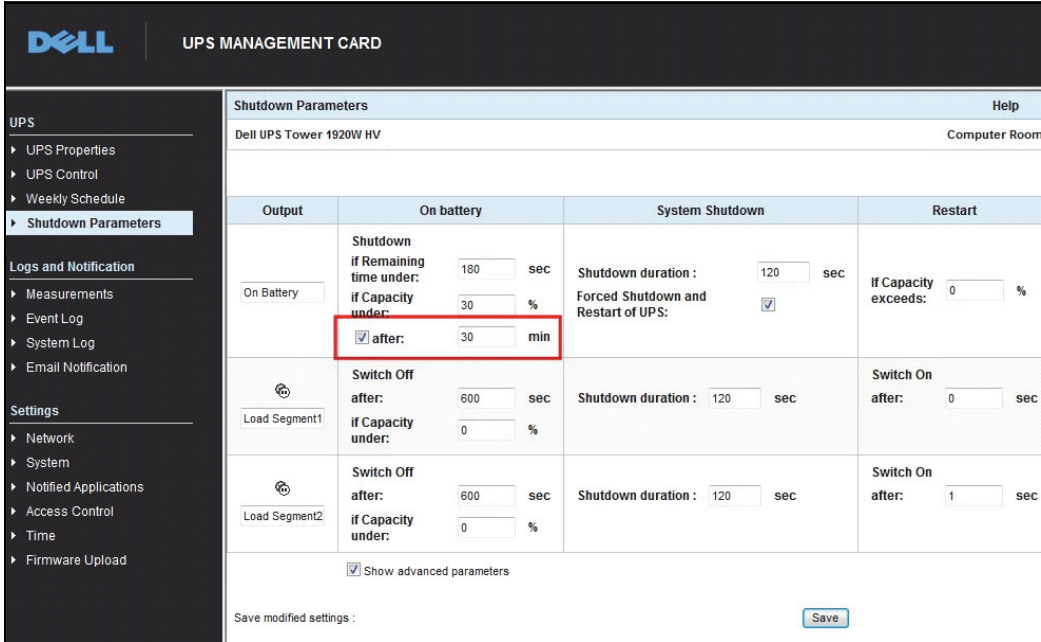

Figure 70. Dell Network Management Card Shutdown Parameters

Use Case #4

You want to have a shutdown when the remaining time of the last UPS is 10 min. In this case, each server can have an individual shutdown duration (10 min, 8 min, 3 min...).

- You need to configure a shutdown duration of 10 min in the Dell ULNM.
 - Figure 71 illustrates the Dell UPS Local Node Manager default configuration available from **Settings > Shutdown > Edit Shutdown Configuration**.

NOTE: This is the default configuration on the Web/ SNMP UPS Card (refer to the previous use case).

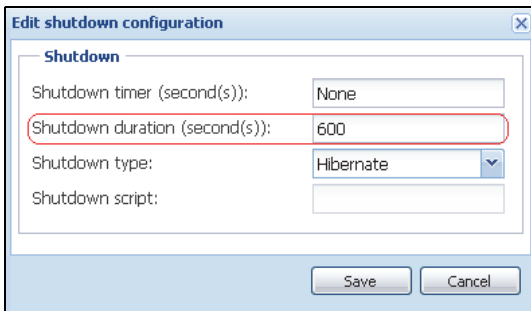

Figure 71. Edit Shutdown Configuration Dialog Box

ULNM with Microsoft Hyper-V or Hyper-V Server

Dell is a first class supplier of hardware and software optimizing business continuity on your Microsoft virtual platforms worldwide, including controlling proper boot and graceful shutdown of the following:

- Virtual machines (VMs) hosted on a same physical machine
- Main operating system hosting Microsoft Hyper-V R1 and R2 or Hyper-V Server

The Dell UPS Local Node Manager (ULNM) is Dell's solution to manage operating system response to power events as follows:

- Continuously waits for information from the UPS management card connected to the Dell UPS

NOTE: The Dell ULNM consolidates information from the UPS that is supplying the server.

- Warns administrators and users if AC power fails
- Shuts down the system before the end of battery backup power is reached
- Restarts machines when AC power restarts

NOTE: Microsoft Hyper-V (or Hyper-V Server) controls VM shutdown and restart functions: the Dell ULNM has no control over VM status or migration.

The ULNM protection software should be installed on the main operating system (hosting Hyper-V) to provide the following advantages:

- Only one deployment of Dell ULNM on a physical machine, to manage all VMs
- Silent deployment possible
- Dynamic management of VM configuration, with a personalized script

See Figure 72 for a configuration diagram.

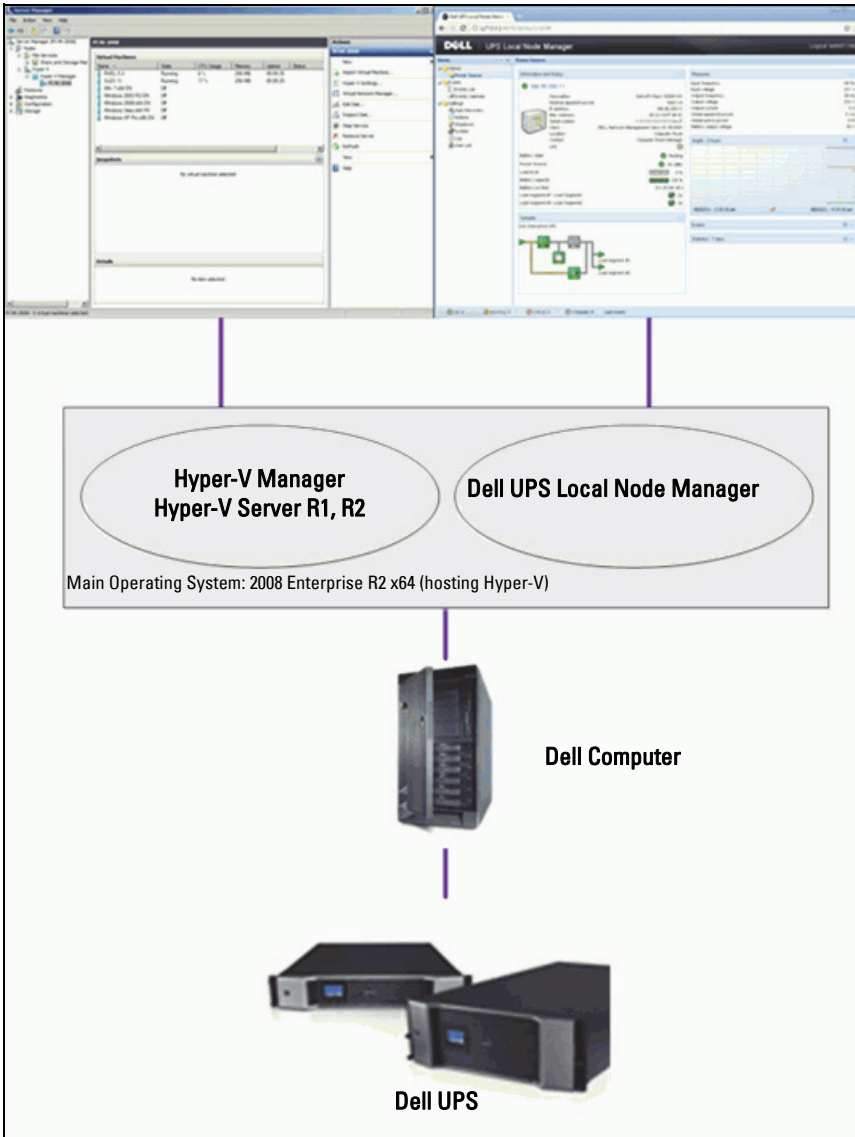

Figure 72. Dell ULNM Configuration for Hyper-V Schema

Dell tested system shutdown, electrical shutdown, and reboot functions to evaluate virtualization power management with a redundant UPS configuration. All operations were tested on a VMware server with two guest operating systems [Windows Small Business Server (SBS) 2003 and Red Hat] when certain conditions existed, including the following:

- UPS battery is low
- Battery backup time is reached
- Battery discharge time is reached

Tested operations include:

- Safe shut down of the VMware server
- Safe shut down of the guest operating system
- Notifications of power events or UPS alerts to the VMware server

Installation Prerequisites

This section guides you through the installation and configuration prerequisites before installing the Dell ULNM on a Microsoft Hyper-V architecture.

This procedure was validated using Microsoft Windows 2008 Enterprise R1, R2 x64 as the main operating system (hosting Hyper-V). Microsoft Hyper-V was hosting several VMs with the following applications installed:

- Windows 2000 Server SP4 and Advanced Server SP4
- Windows Server 2003 x86/x64 R2 SP2
- Windows Server 2008 x86/x64 SP1/SP2
- Windows XP Professional SP2/SP3 and x64 SP2
- Windows Vista SP1/SP2 (except Home editions)
- Windows Seven x86/x64 (except Home editions; only on Server 2008 R2)
- SUSE Linux Enterprise Server 10 SP2 & 11
- Red Hat Enterprise Linux 5.2/5.3/5.4 x86/x64
- Dell ULNM for Windows

This procedure was validated using Hyper-V Server running on an x64 machine. Microsoft Hyper-V Server was hosting with the following applications installed:

- Windows Server SP4 and Advanced Server SP4
- Windows Server 2003 x86/x64 R2 SP2
- Windows Server 2008 x86/x64 SP1/SP2
- Windows XP Professional SP2/SP3 and x64 SP2
- Windows Vista SP1/SP2 (except Home editions)

- Windows 7 x86/x64 (except Home editions; only on Hyper-V Server R2)
- SUSE Linux Enterprise Server 10 SP2 & 11
- Red Hat Enterprise Linux 5.2/5.3/5.4 x86/x64
- Dell ULNM for Windows

NOTE: Hyper-V Server does not support an RS-232 communication port. Connect the UPS through the USB link or through the Network link (optional H910P Dell Network Management Card).

Hyper-V Manager/Hyper-V Server R1 and R2 Configuration Prerequisites

For the automatic OS boot on start-up following a shutdown event, you must configure the physical machine to allow automatic OS boot on start-up. This is found in the machine's BIOS. For further information, see specific documentation of the physical hardware.

NOTE: It may be required to activate Virtualization Technology Enabled (in the machine's BIOS) to run Hyper-V, in *CPU Information > Virtualization Technology > Enabled*.

Guest Component Service Installation

It is necessary to install the additional the Microsoft Guest Component Service to allow Hyper-V to execute graceful VM shutdown.

To install the Microsoft Guest Component Service:

- 1 Open the Hyper-V console and start your VM.
- 2 Select the Action tab and insert the disk integration services.
- 3 Install the Service. To check that installation was successful, verify that the software is available by locating it in **Control Panel > Add / Remove Programs** of the VM.

Services Configuration

To configure services:

- 1 Open the Hyper-V console and select the VM where the service was installed.
- 2 Right-click and choose **Settings > Integration Services**.
- 3 Check the **Operating system shutdown** check box (see Figure 73).

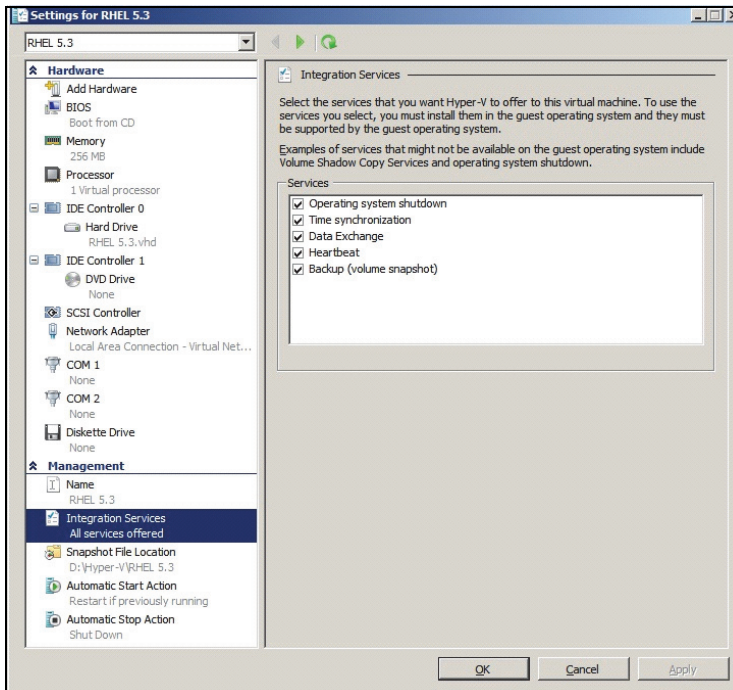

Figure 73. Set Operating System Shutdown

To enable an automatic boot of each VM when Microsoft Hyper-V starts up (Figure 74):

- 1 From the Hyper-V Manager, select the Virtual Machine list.
- 2 Select the VM from the list.
- 3 Select **Parameters > Manage > Automatic Start Action**.
- 4 Choose the appropriate parameters for the VM.

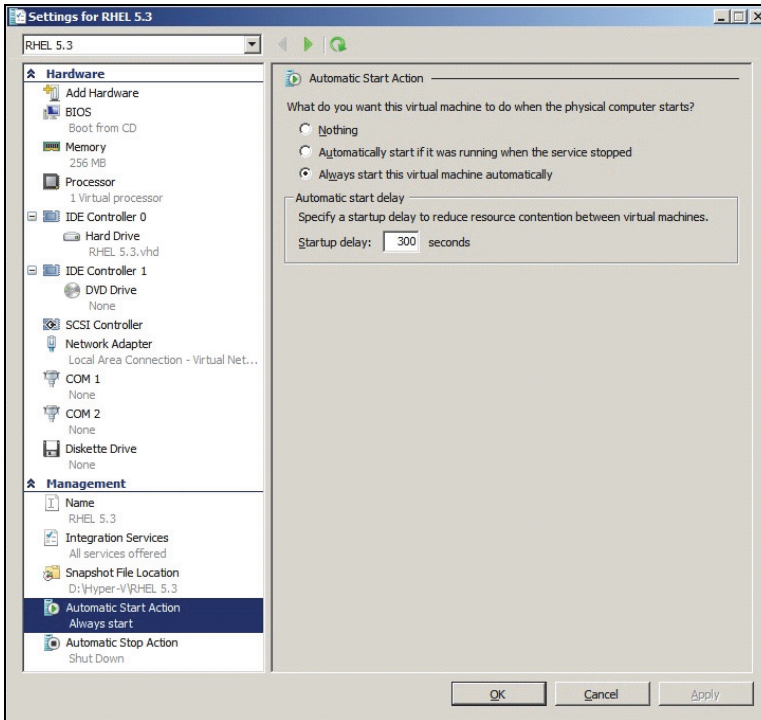

Figure 74. Set Automatic Boot

To ensure an automatic graceful shutdown of each VM when Microsoft Hyper-V stops (Figure 75):

- 1 From the Hyper-V Manager, select the Virtual Machine list.
- 2 Select the VM from the list.
- 3 Select **Parameters > Management > Automatic Stop Actions**.
- 4 Choose the appropriate parameters for the VM.

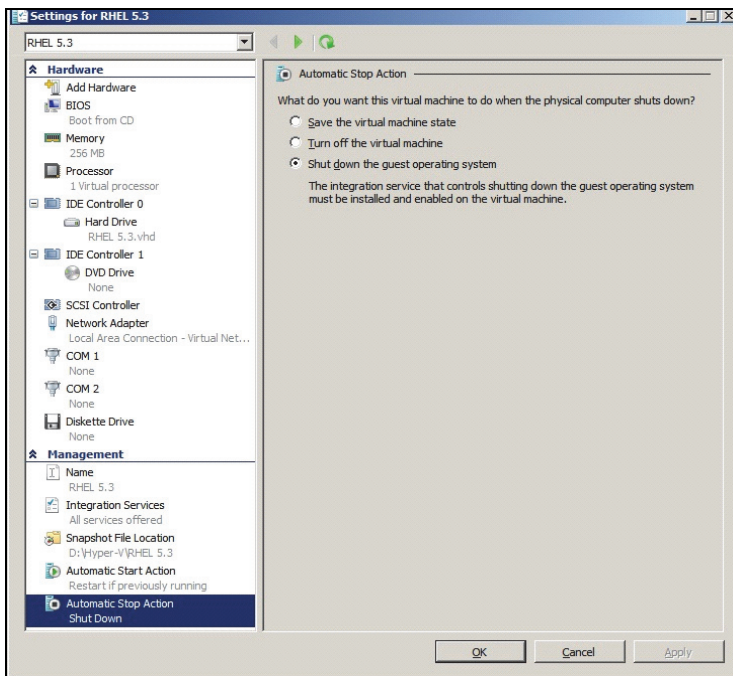

Figure 75. Set Automatic Graceful Shutdown

NOTE: With Windows Hyper-V Server, this configuration will be done remotely.

The MMC Microsoft console is installed on a remote computer running Windows 2008 Server or Vista SP1 (Figure 76).

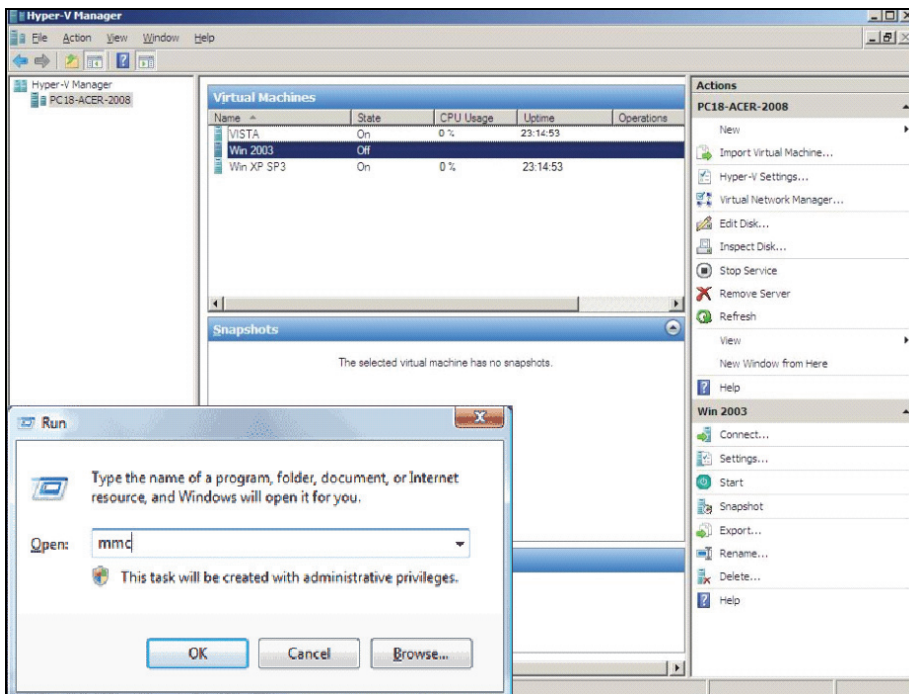

Figure 76. Hyper-V Manager

Dell ULNM Installation Prerequisites

The prerequisites for Dell ULNM installation are described in “Installation Prerequisites” on page 13. Also see “Compatibility” on page 10.

Dell ULNM Network Configuration Prerequisites

All hardware elements must have an operational network configuration that allows free dialog between them. Connections through the following ports must be authorized within the firewall of the main operating system:

- Connections on tcp port 4679 and 4680 to enable a remote access for supervision and configuration through Web browser. These ports are reserved at IANA (<http://www.iana.org/>).
- Connections through TCP port 80 must be opened as a destination port (for output) on the machine hosting Dell ULNM. (This is in order to enable communication between the Dell ULNM and the Dell Network Management Card)

To configure network parameters of the main operating system, please refer to the operating system user’s manual.

Dell ULNM Installation (Hyper-V Server and Windows Server 2008)

To install the Dell ULNM on Hyper-V Server and Windows Server 2008:

- 1 Download the latest version of Dell ULNM Windows version package from Dell's Web site (<http://www.dellups.com/>) and choose the Windows version of Dell ULNM.
- 2 Copy the package on your system.
- 3 Execute the package from the DOS Windows command and navigate to the directory where you placed the Dell UPS Local Node Manager Server 2008 files.
- 4 Follow the Dell ULNM installation instructions in the Installation chapter of this document beginning on page page 13.

Using Dell ULNM with Hyper-V Server R1/R2 or Hyper-V Manager

This section provides an operation quick reference information for using the Dell ULNM with Hyper-V Server R1 and R2 or Hyper-V Manager after installation is completed. More detailed operation information is available beginning on page 31 with the Configuration chapter.

Local Access (for Hyper-V Manager on Windows 2008)

- From the system where Dell ULNM is installed, you can use the following shortcut:
Start > Programs > Dell > UPS Local Node Manager >Open Dell UPS Local Node Manager

Remote access (for Hyper-V Server or Hyper-V Manager on Windows 2008)

- From a remote machine, you can type one of the following URLs in a Web browser:

http://<name or IP address of computer hosting Dell ULNM>:4679/

Or

https://<name or IP address of computer hosting Dell ULNM>:4680/

SSL Mode

- 1 In SSL mode, click **Yes** to accept the certificate.
- 2 Login (admin) / Password (admin) are default access entries. Type the login and password and click **Login** (see Figure 77).

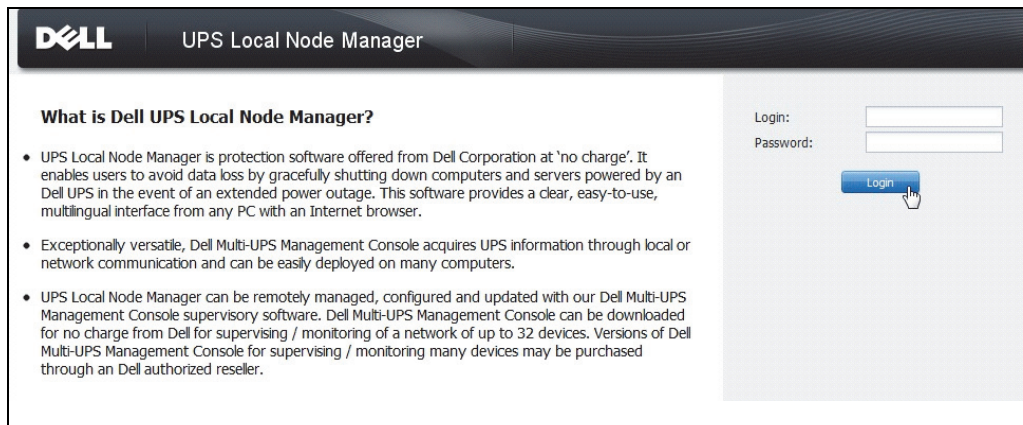



Figure 77. Login Page

Configuration

When started, the application automatically performs a discovery using the “Quick Scan” option for the following UPSs:

- Serial line connected UPSs (RS-232 or USB)

The discovered UPS connected through an RS-232 or USB connection is automatically assigned as the Power Source. The status icon is green .

- Networked UPSs through broadcast within a few seconds (Optional H910P Dell Network Management Card).

The discovered UPSs connected through a network connection are not automatically assigned as the Power Source. You must select the node and click **Set as Power Source**. The status icon becomes green .

- The nodes discovered by “Quick Scan” are displayed in **Settings > Auto Discovery**.

For the other nodes, perform the discovery based on IP address ranges using the “Range Scan” option. Using “Range Scan” discovers the nodes that are outside of the network segment and nodes that are not compatible for discovery using the “Quick Scan” feature.

Other useful configuration operations are:

- Use **Settings > Shutdown** to assign the IP address of the UPS that powers the local Computer.
- Use **Settings > User List** to assign the access rights for users through the login and password entries.

Operation

Use **Views > Power Source** (optional) to supervise the current state of the UPS that powers the server running the Dell ULNM (see Figure 78).

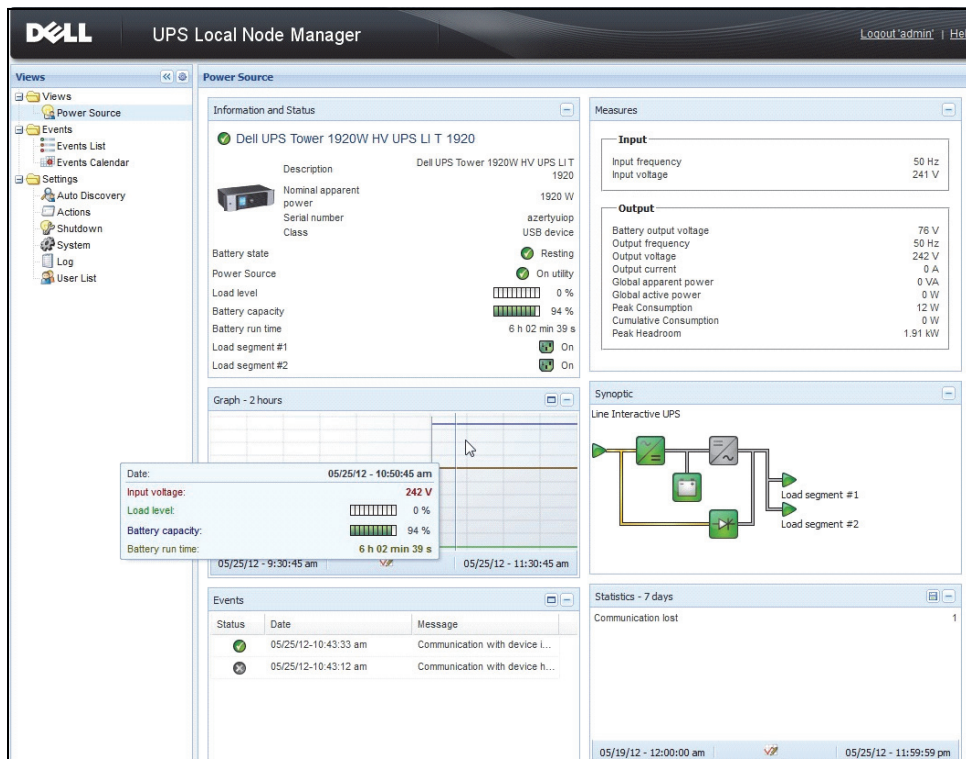

Figure 78. Power Source Main Page

The **Events > Event List** view allows you to view the device events (see Figure 79).

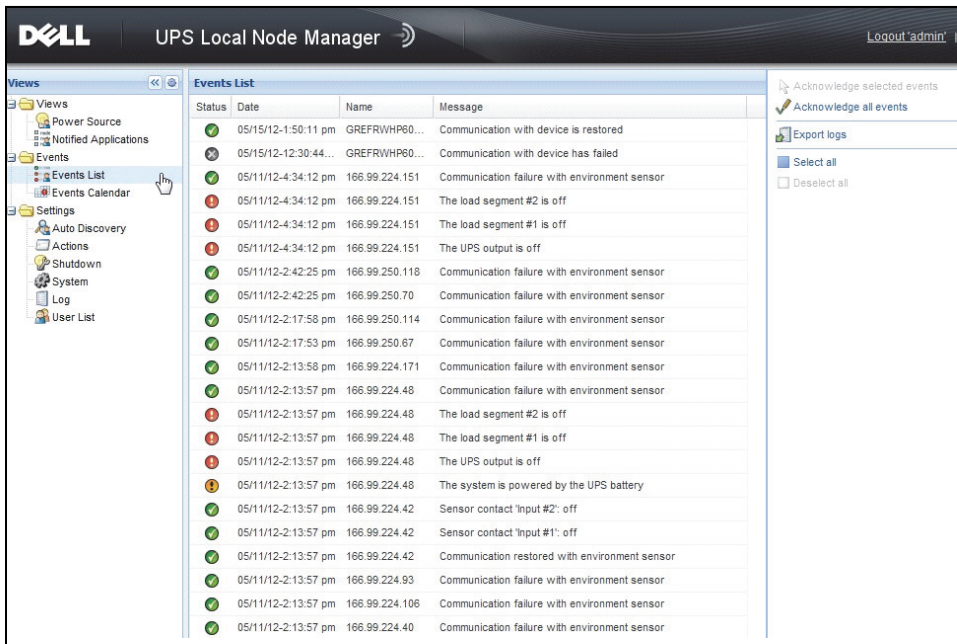

Figure 79. Events List Page

References

Useful Links

- Dell software download page:
<http://www.dellups.com>
- Microsoft Hyper-V reference documents:
<http://www.microsoft.com/windowsserver2008/en/us/hyperv.aspx>

Useful Commands

The following is a useful commands to list Windows services activated:

- `C:\net stat`

```
C:\Windows\system32\cmd.exe
C:\>net start
These Windows services are started:
Application Information
Background Intelligent Transfer Service
Base Filtering Engine
Certificate Propagation
COM+ Event System
Cryptographic Services
DCOM Server Process Launcher
Dell UPS Local Node Manager
Desktop Window Manager Session Manager
DHCP Client
Diagnostic Policy Service
Diagnostic Service Host
Distributed Link Tracking Client
DNS Client
Function Discovery Provider Host
Group Policy Client
IP Helper
Network Connections
Network List Service
Network Location Awareness
Network Store Interface Service
Offline Files
Plug and Play
Power
Print Spooler
Program Compatibility Assistant Service
Remote Desktop Configuration
Remote Desktop Services
Remote Desktop Services UserMode Port Redirector
Remote Procedure Call (RPC)
RPC Endpoint Mapper
Security Accounts Manager
Security Center
Server
Shell Hardware Detection
Software Protection
SPP Notification Service
SSDP Discovery
Superfetch
System Event Notification Service
Tablet PC Input Service
Task Scheduler
TCP/IP NetBIOS Helper
Themes
UPnP Device Host
User Profile Service
Windows Audio
Windows Audio Endpoint Builder
Windows Connect Now - Config Registrar
Windows Defender
Windows Event Log
Windows Firewall
Windows Font Cache Service
Windows Management Instrumentation
Windows Media Player Network Sharing Service
Windows Search
Windows Time
Windows Update
WinHTTP Web Proxy Auto-Discovery Service
Workstation

The command completed successfully.
```

Figure 80. Net start Windows Command

ULNM with VMware ESX Server 4.0 /4.1

The Dell UPS Local Node Manager (ULNM) is the DELL solution to automate virtualized IT system responses to power events as follows:

- Continuously monitors the incoming AC power status
- Warns administrators and users if AC power fails
- Shuts down the system before the end of battery backup power is reached
- Restarts machines when AC power restarts

VMware controls the shutdown and restart of virtual machines (VMs) directly from the administration console, or from an application hosted on the ESX layer. The Dell ULNM is installed on the vMA application layer and provides the following advantages:

- Only one deployment of Dell ULNM on a physical machine, to manage all VMs
- Silent and personalized deployment using the Command Line Interface (CLI) of the Dell ULNM
- Dynamic management of VM configuration, with a personalized script

NOTE: If you are running VMware vCenter, you do not need to install Dell ULNM on each ESXi host. In this case, we offer an agentless solution where the Dell™ Multi-UPS Management Console® (MUMC) can manage multiple ESXi hosts through a single vCenter connection. Refer to the Dell MUMC user's guide for more information about this type of installation.

See Figure 81 for a configuration diagram of a VMware architecture.

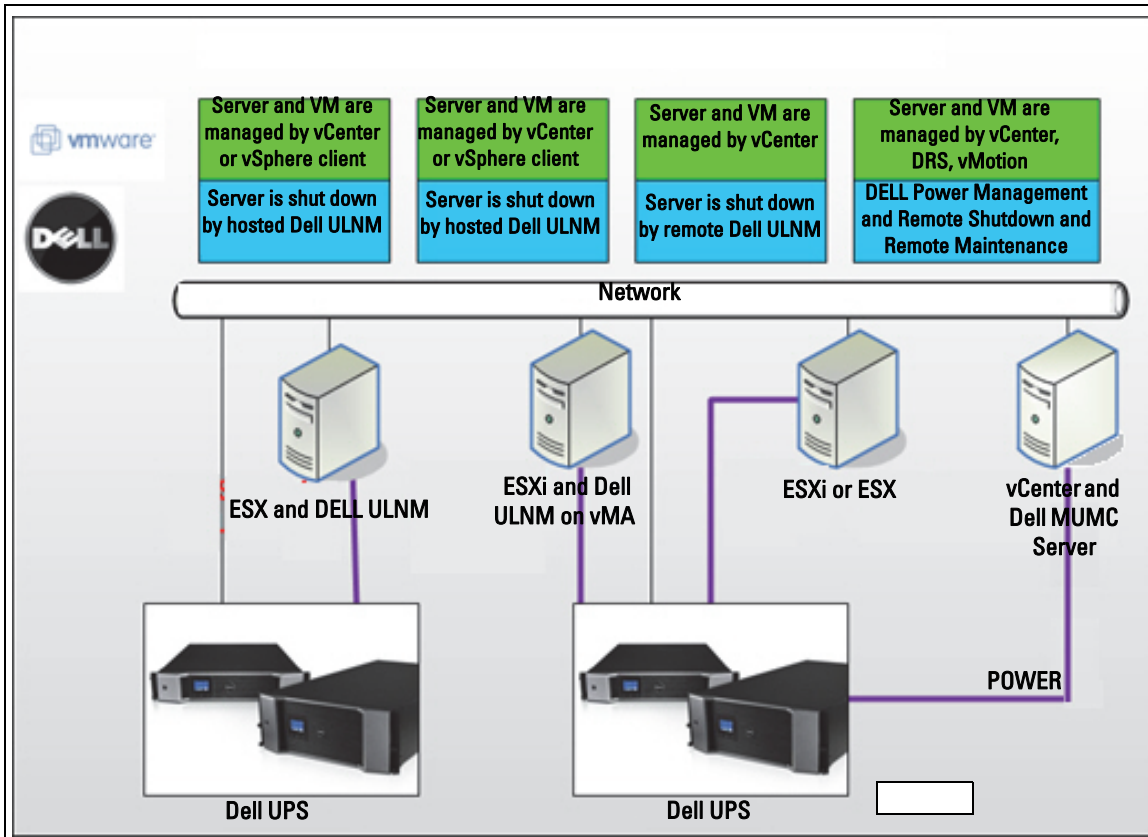

Figure 81. Dell ULNM Configurations for VMware Schema

Dell provides three solutions for VMware that are illustrated in Figure 81.

Solution 1

In this solution, ESX and ESXi hosts are controlled by vCenter (paid version only), which provides following features:

- Agentless host management (Dell ULNM does not need to be installed on each host)
- No CLI programming, or need for vMA
- Remote graceful shutdown of multiple ESX/ESXi servers and hosted VMs
- Ability to set hosts to maintenance mode (to use vMotion)
- A plug-in is created in vCenter for centralized IT and power management
- UPS events are accessible and configurable through vCenter

Solution 2

In this solution, ESX and ESXi hosts not controlled by vCenter (paid version only), which provides following features:

- Dell ULNM application is installed on VIMA/vMA for each host
- Dell ULNM configurations and actions can be managed centrally from the Dell™ Multi-UPS Management Console® client
- Some command line programming is required
- Remote graceful shutdown of multiple ESX/ESXi servers and hosted VMs

NOTE: For paid versions, VMware suppresses the ability to control VM shutdown profiles in non-licensed ESXi installations. There are 3rd party methodologies for avoiding this restriction, but this is not covered in this user guide.

Solution 3

This solution is for ESX-only hosts (paid or free versions), which provides following features:

- Dell ULNM application is installed on each host (on either Windows or Linux VM)
- Remote graceful shutdown of each ESX host and hosted VMs
- Dell ULNM configurations and actions can be managed centrally from Dell MUMC client

Installation Prerequisites

This section guides you through the installation and configuration prerequisites before installing the Dell ULNM on VMware ESX architecture.

Dell validated this procedure on an ESX Server 4.0/4.1 with a Dell ULNM and a distant administration workstation with VMware vSphere Client 4.0.

The following prerequisites apply:

- ESX Server 3.5 is not compatible with Dell ULNM. Use the legacy Dell UPS Management Software (DUMS).
- Through the network, Dell UPSs are compatible with Dell ULNM on ESX.
- Through RS-232, Dell UPSs are compatible with Dell ULNM on ESX.
- To allow a graceful shutdown of the VMs, you must install VMware Tools on each VM.

VMware ESX Server 4.0 Configuration Prerequisites

For automatic OS boot on start-up, you must configure the physical machine to allow automatic OS boot on start-up. This setting is present in your machine's BIOS. For further information, see specific technical hardware documentation.

To allow interactions between physical and virtual machines, VMware tools must be installed on each VM. For further information, see VMware ESX Server documentation.

For the automatic VM boot on VMware ESX start-up:

- From the Virtual Infrastructure Client interface, select **Virtual machine startup / shutdown > Configuration > Properties > Start and stop VMs with the system** and tick Enable.
- On the Properties page, you can define the startup order of your VMs.
 - Start and Stop VMs with the system: Enabled
 - Default Startup Delay: *n* Seconds
 - Default Shutdown Delay: *n* Seconds
 - Startup Order: Automatic Startup

This configuration is illustrated in Figure 82.

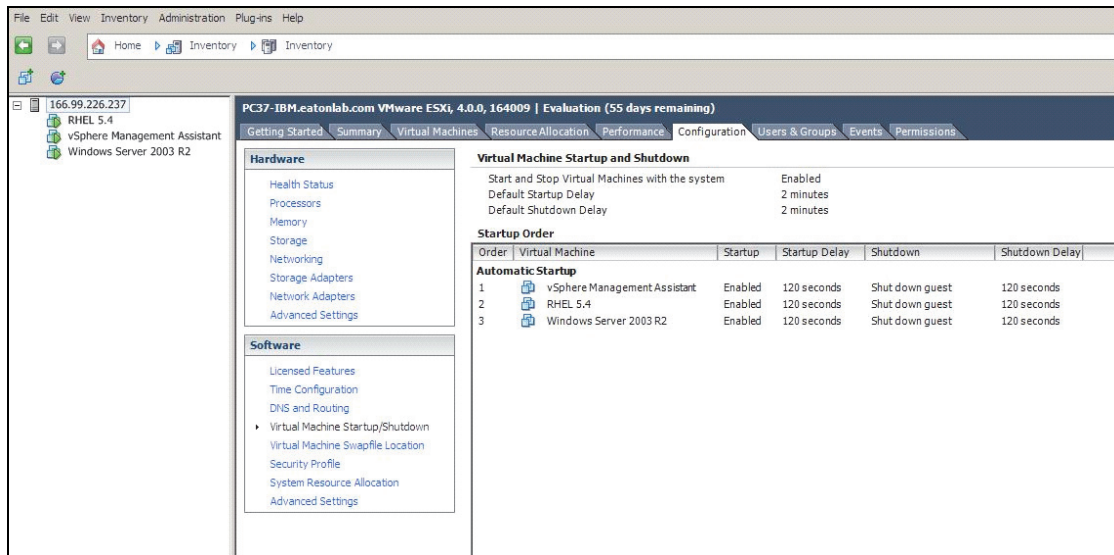

Figure 82. vCenter Page

Dell ULNM Installation Prerequisites

The prerequisites for Dell ULNM installation are described in “Installation Prerequisites” on page 13. Also see “Compatibility” on page 10.

Dell ULNM Network Configuration Prerequisites

All hardware elements must have an operational network configuration that allows free dialog between them. Connections through the following ports must be authorized within the firewall of the main operating system:

- Connections on tcp port 4679 and 4680 to enable a remote access for supervision and configuration through Web browser. These ports are reserved at IANA (<http://www.iana.org/>).
- Connections through TCP port 80 must be opened as a destination port (for output) on the machine hosting Dell ULNM

In order to enable communication between Dell ULNM and the Dell Network Management Card (command line for firewall):

```
esxcfg-firewall -o 4679,tcp, in,DELLhttp
esxcfg-firewall -o 4680,tcp, in,DELLhttps
esxcfg-firewall -o 80,tcp,out,http
esxcfg-firewall -o 5000,tcp,out,DELLinit
esxcfg-firewall -o 4679,udp, in,DELLhttpU
esxcfg-firewall -o 4680,udp, in,DELLhttpsU
```

- In order to enable communication between Dell ULNM and the Dell UPS Network Management Card (command line for firewall 2):

```
esxcfg-firewall -o 161,udp, in,DELL-ULNM
esxcfg-firewall -o 200,udp, in,DELL-ULNM
esxcfg-firewall -o 2844,udp, in,DELL-ULNM
esxcfg-firewall -o 2845,udp, in,DELL-ULNM
esxcfg-firewall -o 161,udp,out,DELL-ULNM
esxcfg-firewall -o 200,udp,out,DELL-ULNM
esxcfg-firewall -o 2844,udp,out,DELL-ULNM
esxcfg-firewall -o 2845,udp,out,DELL-ULNM
```

NOTE: To configure the VMware ESX Server for the network, please refer to the VMware ESX user's manual.

Dell ULNM Installation (VMware ESX Server 4.0, 4.1)

To install the Dell ULNM on VMware ESX Server 4.0, 4.1:

- 1 Download the latest version of the Dell ULNM from <http://www.dellups.com/>.

NOTE: When you download the latest version of Dell ULNM, it will automatically detect ESX Server, and will generate shutdown command script. This shutdown.sh script will be installed in <installation folder>/bin/tools, by default /usr/local/DELL/UPSLocalNodeManager/bin/virt_tools/.

- 2 Select **Network solution**.
- 3 Select **Linux - VMWare ESX** as the operating system.
- 4 Download the Linux generic version (Dell UPS Local Node Manager Linux x86 Console) named ulnm-linux-x_xx_xxx-i386.run.

NOTE: You can use the .rpm package for the installation. Choose the best package for your implementation in the Web page. For example, the only installation command required for rpm package is "rpm -ivh ulnm-linux-x_xx_xxx-i386.rpm."

- 5 Upload the package on your VMware ESX environment, with a SCP Client. (Example under windows environment: WinSCP)
- 6 Connect with SSH to the VMware server. (Example under Windows environment: Putty.) You must have corresponding rights to execute and install programs on VMware ESX. Refer to VMware ESX for further information.
- 7 In the upload folder, add execution right to the package by typing:

```
chmod 755 ulnm-linux-x_xx_xxx-i386.run.
```

If you store the installation file on the shared vmfs resources in a SAN, you could have an error message when you start the installer, such as: `/ulnm-linux-x_xx_xxx-i386.run: cannot execute binary file`

If this occurs, copy the installation source to the local drive of the ESX server

- 8 Install Dell ULNM by typing:

```
./ulnm-linux-x_xx_xxx-i386.run -install -silent
```

Silent Installation

For silent Dell ULNM installation process, please refer to "Silent Installation" on page 25.

- 1 When completed, connect to the Dell ULNM using your Web browser by typing one of the following:
 - For HTTP access: `http://<@IP-or-name-of-ESX>:4679`
 - For HTTPS access: `https://<@ IP-or-name-of- ESX>:4680`
- 2 The Dell ULNM interface will be displayed.

Using ULNM with VMware for ESX Server 4.0/4.1

This section provides an operation quick reference information for using the Dell ULNM with VMware for ESX Server 4.0 and 4.1 after installation is completed. More detailed operation information is available beginning in Chapter 3.

Remote access (for VMware ESX Server 4.0, 4.1)

- From a remote machine, you can type one of the following URLs in a Web browser:
http://<name or IP address of computer hosting Dell ULNM>:4679/

Or

https://<name or IP address of computer hosting Dell ULNM>:4680/

SSL Mode

- 1 In SSL mode, click **Yes** to accept the certificate.
- 2 Login (admin) / Password (admin) are default access entries. Type the login and password and click **Login** (see Figure 83).

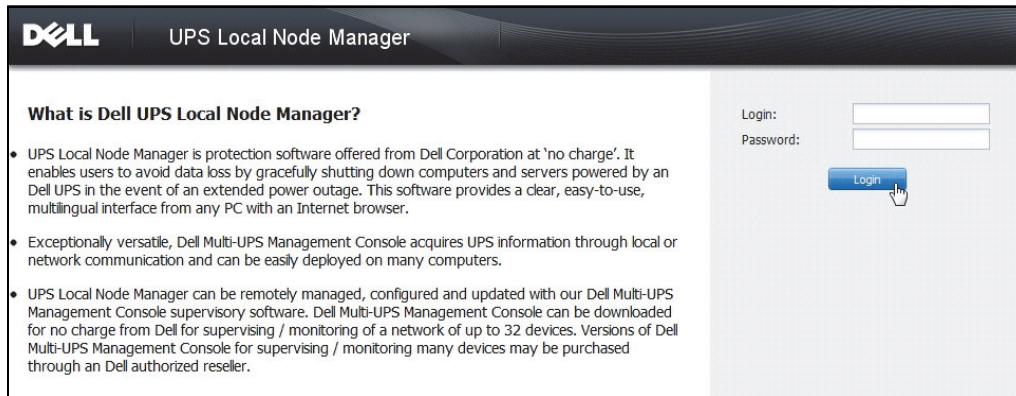



Figure 83. Login Page

Configuration

When started, the application automatically performs a discovery using the “Quick Scan” option for the following UPSs:

- Serial line connected UPSs (RS-232 or USB)

The discovered UPS connected through an RS-232 or USB connection is automatically assigned as the Power Source. The status icon is green .

- Networked UPSs through broadcast within a few seconds (Optional H910P Dell Network Management Card)

The discovered UPSs connected through a network connection are not automatically assigned as the Power Source. You must select the node and click **Set as Power Source**. The status icon becomes green .

- The nodes discovered by “Quick Scan” are displayed in **Settings > Auto Discovery**.

For the other nodes, perform the discovery based on IP address ranges using the “Range Scan” option. Using “Range Scan” discovers the nodes that are outside of the network segment and nodes that are not compatible for discover using the “Quick Scan” feature.

- Use **Settings > Shutdown** to assign the IP address of the UPS that powers the local Computer.
- Use **Settings > User List** to assign the access rights for users through the login and password entries.

Operation

Use **Views > Power Source** (optional) to supervise the current state of the UPS that powers the server running the Dell ULNM (see Figure 84).

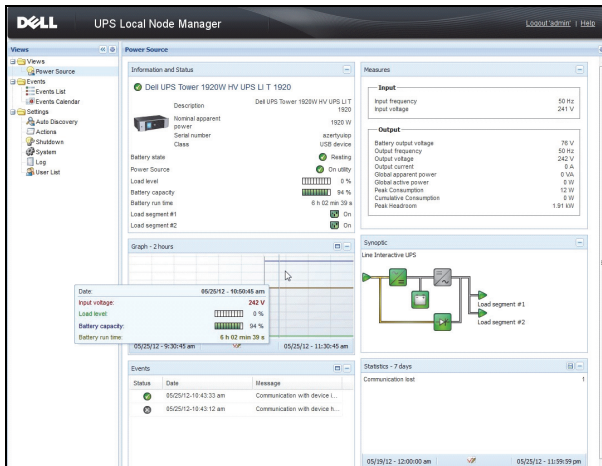

Figure 84. Power Source Main Page

The **Events > Event List** view allows you to view the device events (see Figure 85).

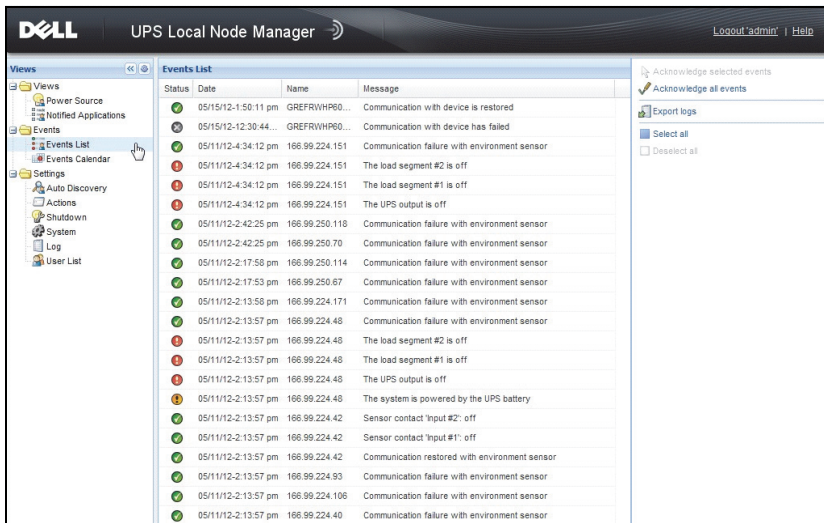

Figure 85. Events List Page

References

Reference documents for VMware ESX Server are available on VMware Web site:

http://www.VMware.com/support/pubs/vi_pubs.html

Reference documents for VMware tools are available in Installation of VMware tools:

Basic System Administration ESX Server and vSphere Client manual in the chapter titled, “Installing and Upgrading VMWare Tools.”

NOTE: Use the appropriate manual version.

ULNM with VMware ESXi Server 4.0/4.1/5.0

The Dell UPS Local Node Manager (ULNM) is the DELL solution to automate virtualized IT system responses to power events as follows:

- Continuously monitors the incoming AC power status
- Warns administrators and users if AC power fails
- Shuts down the system before the end of battery backup power is reached
- Restarts machines when AC power restarts

VMware ESXi does not have an administrative console and we cannot install Dell ULNM on that machine. However, we can install the Dell ULNM on VMware Infrastructure Management Assistant (VIMA) version 1.0, or on vSphere Management Assistant (vMA) version 4.0. Using that, we can manage and shutdown the VMware ESXi in case of UPS and power anomalies.

We can also configure ESXi to safely suspend or shut down guest operating systems. This way, we can have only one Dell ULNM shutdown agent on only one guest operating system (VIMA, vMA).

Installing the Dell ULNM client on the VIMA, vMA instead of each virtual machine (VM) provides the following benefits:

- Only one binary of Dell ULNM client on the VIMA/ vMA to manage all VMs.
- Dynamic management of VM configuration with a personalized script.

See Figure 86 for a configuration diagram of a VMware architecture.

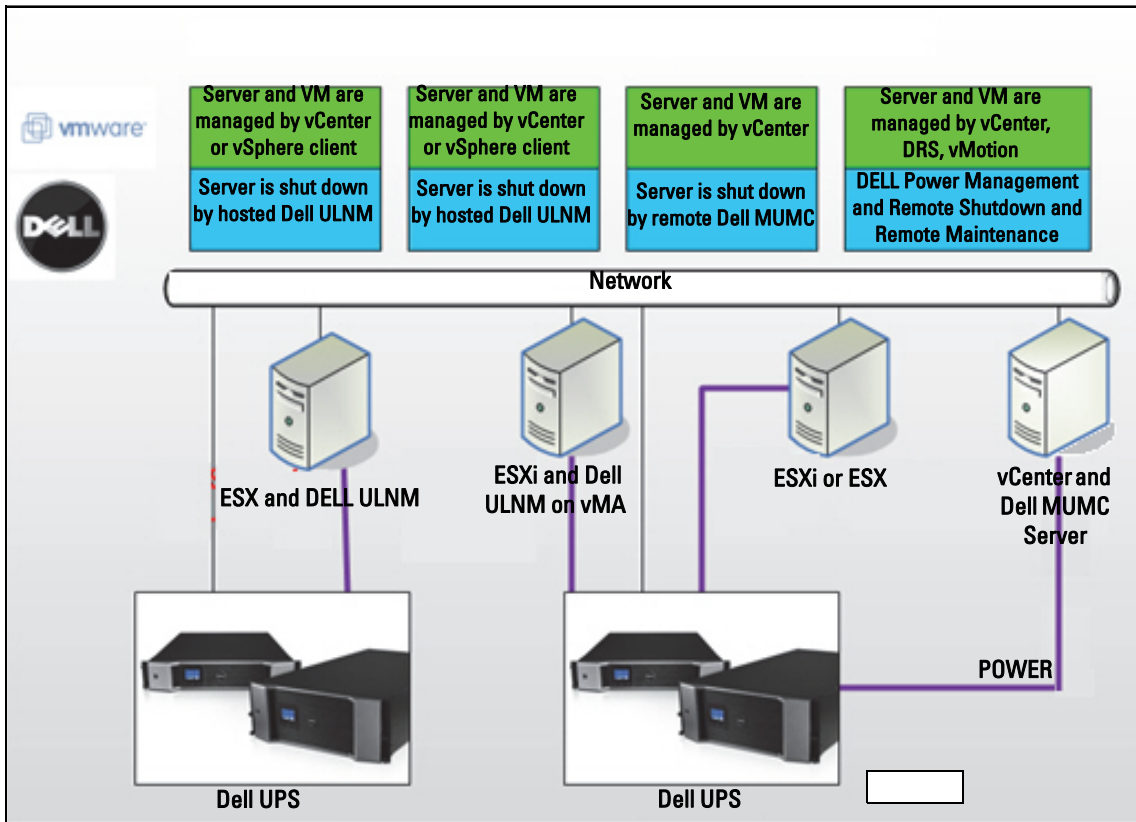

Figure 86. Dell ULNM Configurations for VMware Schema

Dell provides three solutions for VMware that are illustrated in Figure 86.

Solution 1

In this solution, ESX and ESXi hosts are controlled by vCenter (paid version only), which provides following features:

- Agentless host management (Dell ULNM does not need to be installed on each host)
- No Command Line Interface (CLI) programming, or need for vMA
- Remote graceful shutdown of multiple ESX/ESXi servers and hosted VMs
- Ability to set hosts to maintenance mode (to use vMotion)
- A plug-in is created in vCenter for centralized IT and power management
- UPS events are accessible and configurable through vCenter

Solution 2

In this solution, ESX and ESXi hosts not controlled by vCenter (paid version only), which provides following features:

- Dell ULNM application is installed on VIMA/vMA for each host
- Dell ULNM configurations and actions can be managed centrally from the Dell™ Multi-UPS Management Console® client
- Some CLI programming is required
- Remote graceful shutdown of multiple ESX/ESXi servers and hosted VMs

NOTE: For paid versions, VMware suppresses the ability to control VM shutdown profiles in non-licensed ESXi installations. There are 3rd party methodologies for avoiding this restriction, but this is not covered in this user guide.

Solution 3

This solution is for ESX-only hosts (paid or free versions), which provides following features:

- Dell ULNM application is installed on each host (on either Windows or Linux VM)
- Remote graceful shutdown of each ESX host and hosted VMs
- Dell ULNM configurations and actions can be managed centrally from the Dell MUMC client

NOTE: This solution is ideal for large infrastructures working through vCenter server. This solution is described in more detail in the Dell MUMC user's guide.

Installation Prerequisites

This section guides you through the installation and configuration prerequisites before installing the Dell ULNM on VIMA or vMA.

Dell ULNM client was tested on a VMware virtualization server with two guest operating systems (Windows Server 2003 R2 & Red Hat 5.4) for the following:

- electrical power events
- shutdown
- low battery
- reboot
- Dell ULNM on VMware ESXi architecture

The following prerequisites apply:

- VMware ESXi Server Machine up and running
- Only ESXi pay version is supported by this solution
- VMware Infrastructure Management Assistant VIMA 1.0 or vSphere Management Assistant (vMA 4.0 or 5.0) installed as guest
- Sphere Client installed on different machine to VMware ESXi Server configuration
- Dell ULNM package
- SSH client for installation and configuration
- SCP Client to upload packages to VIMA/vMA
- VMware tools installed on each VM

NOTE: DELL UPSs with the optional H901P Dell Network Management Card are compatible with the Dell ULNM on ESXi.

NOTE: RS-232 /USB connections of the Dell UPSs with ESXi host are not supported.

VMware free-versions suppress the ability for an application such as the Dell ULNM to manage host shutdown profiles. There are third-party scripts that provide a workaround to this situation, but they are not supported by this user's guide and may affect your terms of free ESXi license use.

NOTE: Visit <http://www.vmware.com/support/developer/vima/> for more information about download and installation of VIMA or vMA on ESXi host machines.

VMware ESXi Server 4.0/4.1/5.0 Configuration Prerequisites

For automatic OS boot on start-up, you must configure the physical machine to allow automatic OS boot on start-up. This setting is present in your machine's BIOS. For further information, see specific technical hardware documentation.

To allow interactions between physical and virtual machines, VMware tools must be installed on each VM. For further information, see VMware ESX Server documentation.

The following procedure describes configuration of VIMA/vMA shutdown and startup properties:

- 1 From the Virtual Infrastructure Client interface, select the top-most item ESXi host server from left hand side tree hierarchy (see Figure 87).



Figure 87. Hierarchy Selection

2 Select the Configuration tab (see Figure 88).

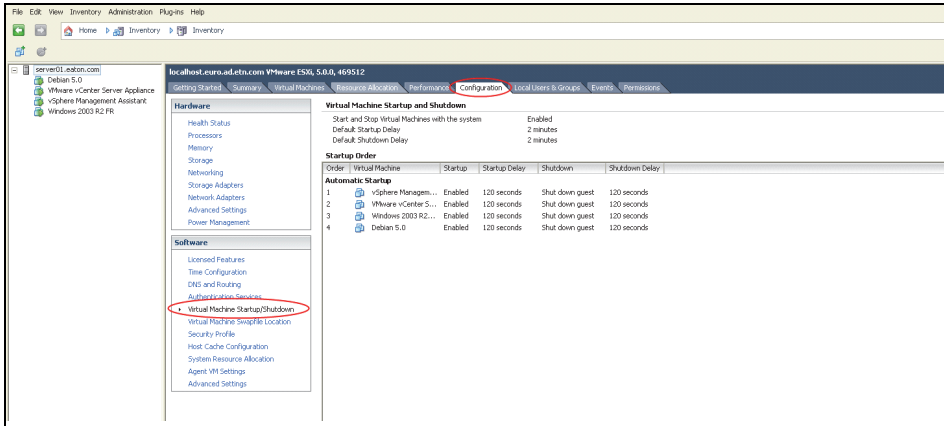

Figure 88. VMware Configuration Tab

3 Select Virtual machine startup / shutdown (see Figure 89). Click Properties in right-hand corner.

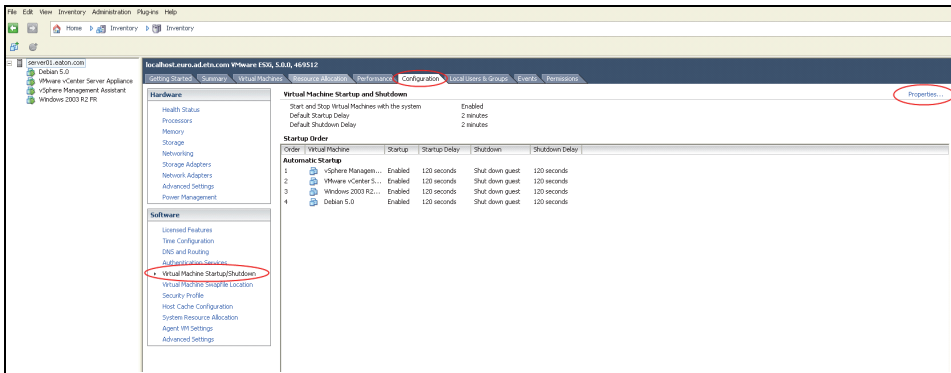

Figure 89. Properties Panel

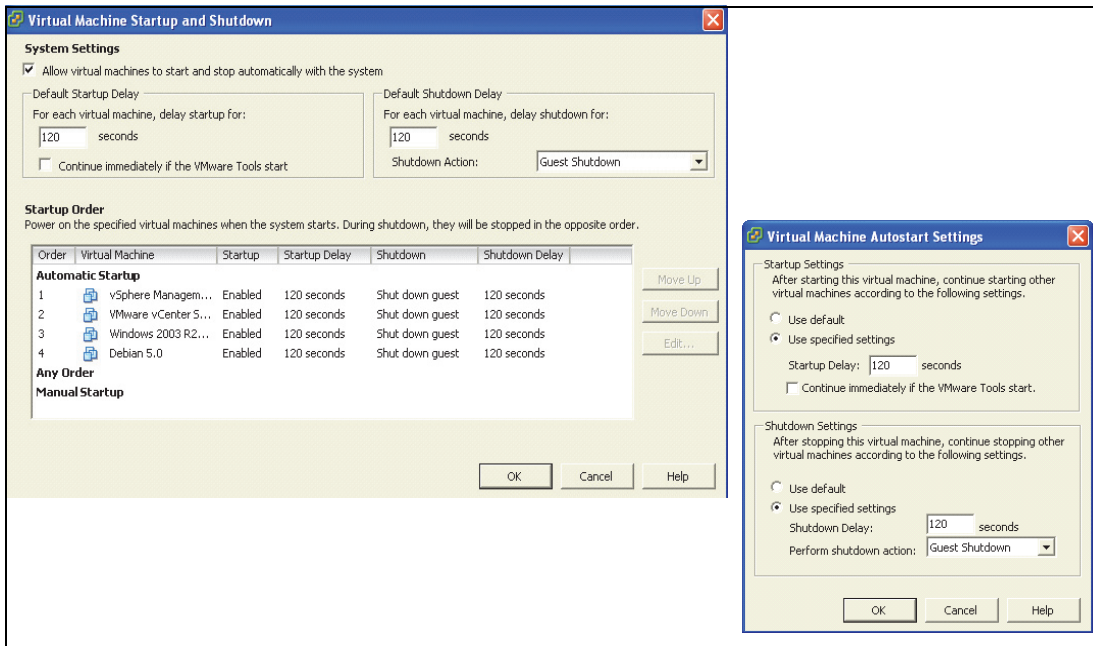

Figure 90. Virtual Machine Startup and Shutdown

- 4 Select VIMA/vMA guest machine and click Edit to configure, as shown in Figure 90.

Startup Settings

- Click Use specified settings
- Set Startup delay - 120 Seconds

Shutdown Settings

- Click Use specified settings
- Shutdown delay - 120 seconds

For the automatic VM boot of other guest machines on VMware ESXi start-up:

- From the Virtual Infrastructure Client interface, select **Virtual machine startup / shutdown > Configuration > Properties > Start and stop VMs with the system** and check Enable.
- On the Properties page, you can define the startup order of your VMs:
 - Start and Stop VMs with the system: Enabled
 - Default Startup Delay: *n* seconds
 - Default Shutdown Delay: *n* seconds
 - Startup Order: Automatic Startup

Dell ULNM Installation Prerequisites

The prerequisites for Dell ULNM installation are described in “Installation Prerequisites” on page 13. Also see “Compatibility” on page 10.

Dell ULNM Network Configuration Prerequisites

All hardware elements must have an operational network configuration that allows free dialog between them.

NOTE: vMA 5 (Suse OS) does not require firewall settings.

Ensure, in particular, that vMA firewall authorizes the following:

- Connections on tcp port 4679 and 4680 to enable a remote access for supervision and configuration through Web browser. These ports are reserved at IANA (<http://www.iana.org>).
- Connections through TCP port 80. It must be opened as a destination port (for output) on the machine hosting Dell ULNM.

This step is not needed on vMA 5 (Suse OS).

- To enable communication between the Dell ULNM and Dell Dell Network Management Card.

```
sudo iptables -I OUTPUT -p tcp --dport 80 -j ACCEPT
sudo iptables -I OUTPUT -p tcp --dport 5000 -j ACCEPT
sudo iptables -I INPUT -p tcp --dport 4679 -j ACCEPT
sudo iptables -I INPUT -p tcp --dport 4680 -j ACCEPT
sudo iptables -I INPUT -p udp --dport 4679 -j ACCEPT
sudo iptables -I INPUT -p udp --dport 4680 -j ACCEPT
```

- To enable communication between Dell ULNM and the optional Dell UPS Network Management Card:

```
sudo iptables -I INPUT -p udp --dport 161 -j ACCEPT
sudo iptables -I INPUT -p udp --dport 200 -j ACCEPT
sudo iptables -I INPUT -p udp --dport 2844 -j ACCEPT
sudo iptables -I INPUT -p udp --dport 2845 -j ACCEPT
sudo iptables -I OUTPUT -p udp --dport 161 -j ACCEPT
sudo iptables -I OUTPUT -p udp --dport 200 -j ACCEPT
sudo iptables -I OUTPUT -p udp --dport 2844 -j ACCEPT
sudo iptables -I OUTPUT -p udp --dport 2845 -j ACCEPT
```

The following step is not needed on vMA 5 (Suse OS)

- Save firewall settings using following command:

NOTE: In this command we propose the -I (insert) option, but it is possible to use -A (append) as well. It is not exactly the same command. Please refer to firewall documentation for the best command for you.

```
> service iptables save
```

NOTE: To configure your VMware ESXi Server for the network, please refer to the user's manual.

Dell ULNM Installation (VMware ESXi 4.0/ 4.1/5.0)

To install the Dell ULNM on Dell ULNM on VIMA or vMA and as a shutdown agent for VMware ESXi architecture:

- 1 Download the latest version of the Dell ULNM from <http://www.dellups.com/>.

NOTE: When you download the latest version of Dell ULNM, it will automatically detect ESXi Server, and will generate shutdown command script. This shutdown.sh script will be installed in <installation folder>/bin/, by default /usr/local/DELL/UPSLocalNodeManager/bin/.

- 2 Select **Network solution**.
- 3 Select **VMware** as the operating system.
- 4 Download the Linux version for ESXi (Dell UPS Local Node Manager Linux x86 Console) named ulnm-linux-x.x.xxx.x86_64.rpm.
- 5 Upload the package on your VIMA/vMA environment, with a SCP Client.
- 6 Connect with SSH to the vMA. You must have corresponding rights to execute and install programs on VIMA/vMA. Refer to VMware Documentation for further information.

NOTE: If you are not the root user when you start the installer, you will be have an error, "can't create transaction lock." To solve the problem, type "sudo -s" to get a root console and run the installer again.

- 7 Install Dell ULNM by typing:

```
[vma ~]$ rpm -i ulnm-linux-x.xx.xxx-x.x86_64.rpm
```

Silent Installation

For silent Dell ULNM installation process, please refer to "Silent Installation" on page 25.

- 1 When completed, connect to the Dell ULNM using your Web browser by typing one of the following:
 - For HTTP access: <http://<@IP-or-name-of-vMA>:4679>
 - For HTTPS access: <https://<@IP-or-name-of-vMA>:4680>
- 2 The Dell ULNM interface will be displayed.

Using Dell ULNM with VMware for ESXi Server 4.0/4.1/5.0

This section provides an operation quick reference information for using the Dell ULNM with VMware for ESXi Server 4.0, 4.1, and 5.0 after installation is completed. More detailed operation information is available beginning in Chapter 3.

Remote access (for VMware ESXi Server 4.0/4.1/5.0)

- 1 From a remote machine, you can type one of the following URLs in a Web browser:

http://<name or IP address of VMA hosting Dell ULNM>:4679/

Or

https://<name or IP address of VMA hosting Dell ULNM>:4680/

SSL Mode

- 1 In SSL mode, click **Yes** to accept the certificate.
- 2 Login (admin) / Password (admin) are default access entries. Type the login and password and click **Login** (see Figure 91).

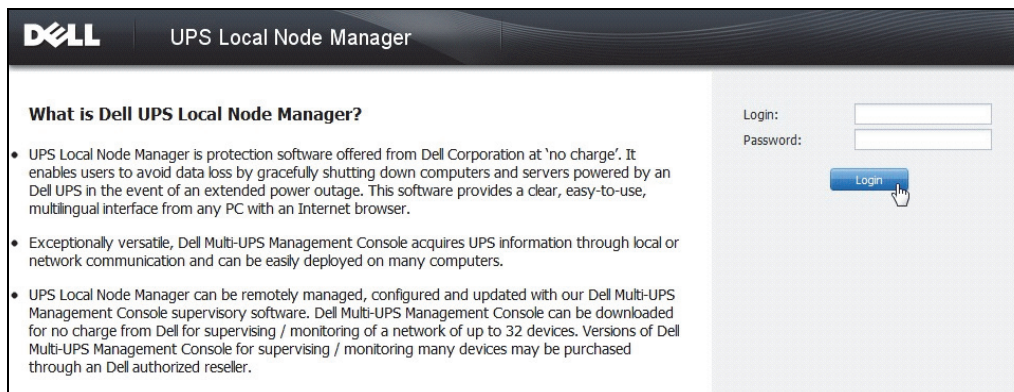



Figure 91. Login Page

Configuration

- 1 When started, the application automatically performs a discovery using the “Quick Scan” option for the following UPSs:
 - Networked UPSs through broadcast within a few seconds (Optional H910P Dell Network Management Card).

The discovered UPSs connected through a network connection are not automatically assigned as the Power Source. You must select the node and click **Set as Power Source**. The status icon becomes green .

- The nodes discovered by “Quick Scan” are displayed in **Settings > Auto Discovery**.
- 2 For the other nodes, perform the discovery based on IP address ranges using the “Range Scan” option.
 - Using “Range Scan” discovers the nodes that are outside of the network segment and nodes that are not compatible for discover using the “Quick Scan” feature.
 - Use **Settings > Shutdown** to assign the IP address of the UPS that powers the local Computer.
 - Use **Settings > User List** to assign the access rights for users through the login and password entries.
 - 3 Edit the shutdown configuration and use the **Script** value for shutdown type. In the **Shutdown script** field, write one of the following lines (see Figure 92):
 - For Dell UPS Local Node Manager - Release 1 (Version 01.02.0006):

```
bin/shutdownESXi.pl --server @ServerIP/Name --username  
Server_username --password Server_Password
```
 - Dell UPS Local Node Manager - Release 2 (Version 01.04.0007):

```
perl bin/virt_tools/shutdownESXi.pl --server @ServerIP/Name --  
username Server_username --password Server_Password
```
 - 4 Modify the following parameters with the information specific to your environment:
 - @ServerIP/Name: IP of the ESXi Server (like 10.1.0.250)
 - Server_username: Name of an Administrator User of your ESXi Server
 - Server_Password: Password of the Administrator User

Edit shutdown configuration

Source

Power source: 10.0.1.64

Outlet

Load segment: Master output

Access parameters

Login:

Password:

Shutdown

Shutdown timer (sec): None

Shutdown duration (sec): 120

Shutdown type: Script

Shutdown script: bin/virt_tools/shutdownESXi.pl --server 10.0.1.53 --username john --password secretPass

Save Cancel

Figure 92. Edit Shutdown Configuration Page

Operation

Use **Views > Power Source** (optional) to supervise the current state of the UPS that powers the server running the Dell ULNM (see Figure 93).

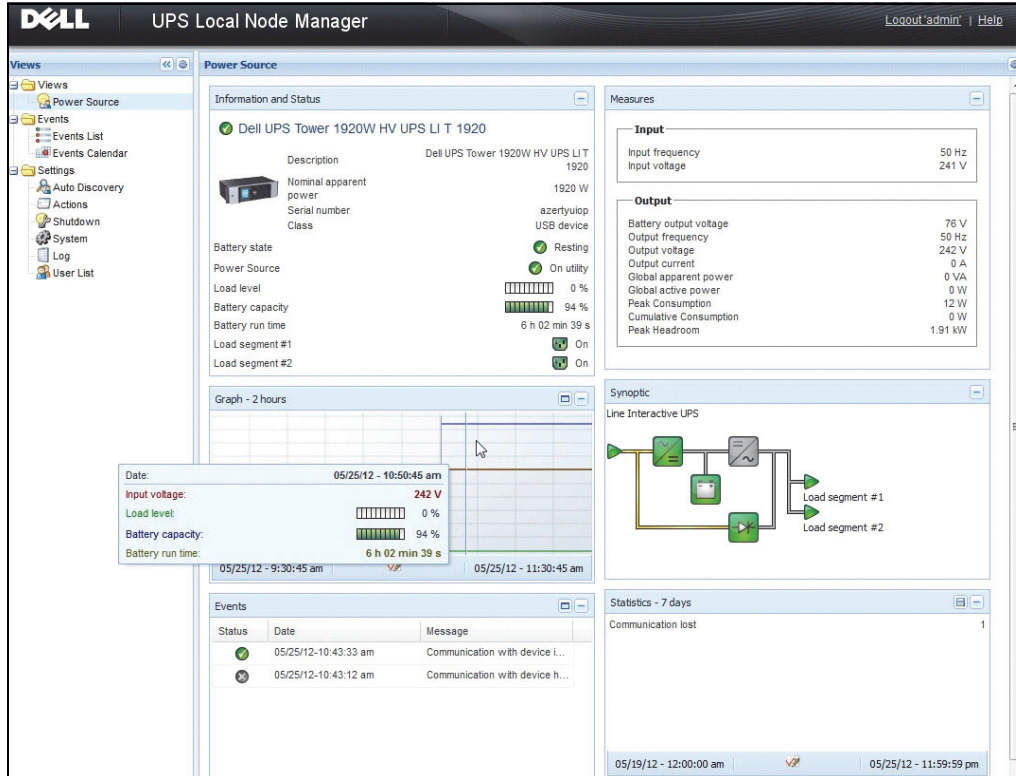

Figure 93. Power Source Main Page

The **Events > Event List** view allows you to view the device events (see Figure 94).

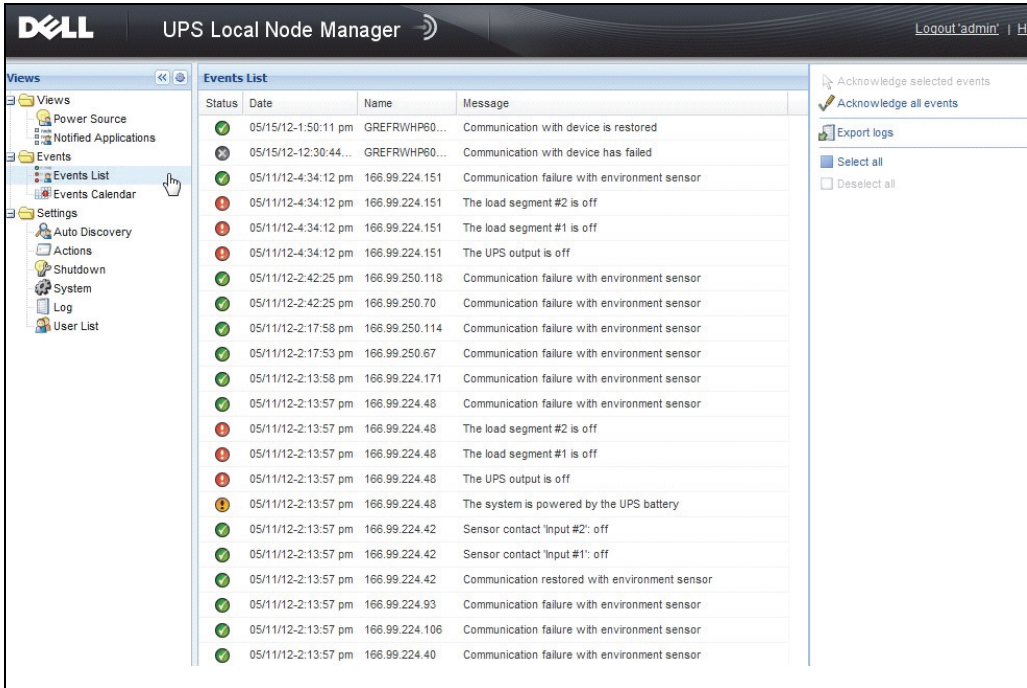

Figure 94. Events List Page

References

- Reference documents for VMware ESX Server are available on VMware Web site:
http://www.VMware.com/support/pubs/vi_pubs.html
- Reference documents for VMware ESX Server are available on VMware Web site:
http://www.VMware.com/support/pubs/vi_pubs.html
- Visit <http://www.vmware.com/support/developer/vima/> for more information about download and installation of VIMA or vMA on ESX/ESXi host machines.

ULNM with Xen Virtualized Architecture

The Dell UPS Local Node Manager (ULNM) discovers and supervises Dell UPSs and PDUs connected across a network, either by means of a card or proxy. It supervises the remote servers hosting the Dell ULNM and also provides local computer graceful shutdown. The Dell ULNM interface can be accessed remotely using a Web browser. Our objective is to provide virtualization support for Dell ULNM power protection software.

The Xen virtualized architecture includes the following:

- Citrix XenServer 5.6
- OpenSource Xen 2.6 on RHEL 5
- OpenSource Xen 3.2 on Debian 5.0 (Lenny)

Figure 95 also illustrates two solutions for Citrix Xen:

- The first solution provides graceful shutdown for Citrix Xen. The Dell ULNM is installed on each Citrix Xen system and does not require XenCenter management software
- The second solution serves multiple Xen servers and provides the following features:
 - Xen server remote maintenance to trigger VM XenMotion
 - Xen server remote shutdown (with the Dell ULNM)
 - This solution is ideal for biggest infrastructures working through XenCenter

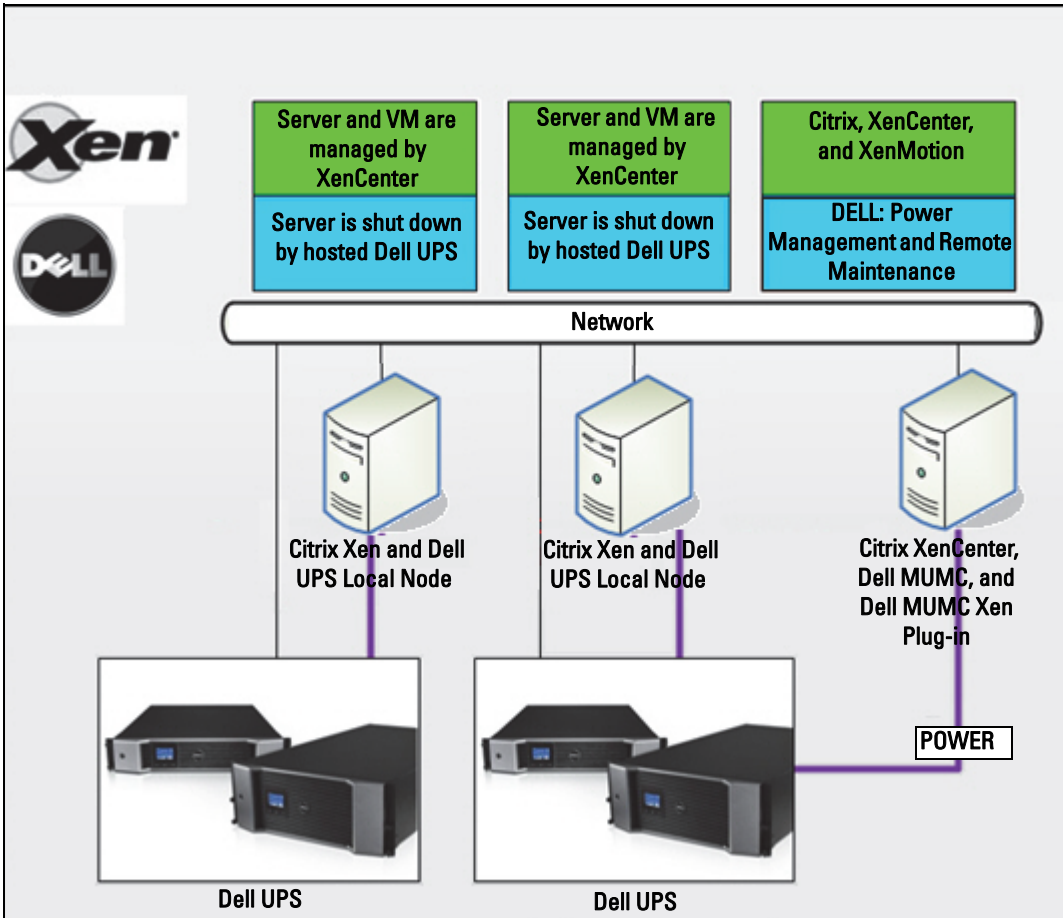

Figure 95. Dell ULNM Solutions for Citrix XenServer

As illustrated in Figure 96, the Dell ULNM is installed on each OpenSource Xen system and provides a graceful shutdown solution for Xen virtualization environments installed on each Xen system. This solution does not require XenCenter management software.

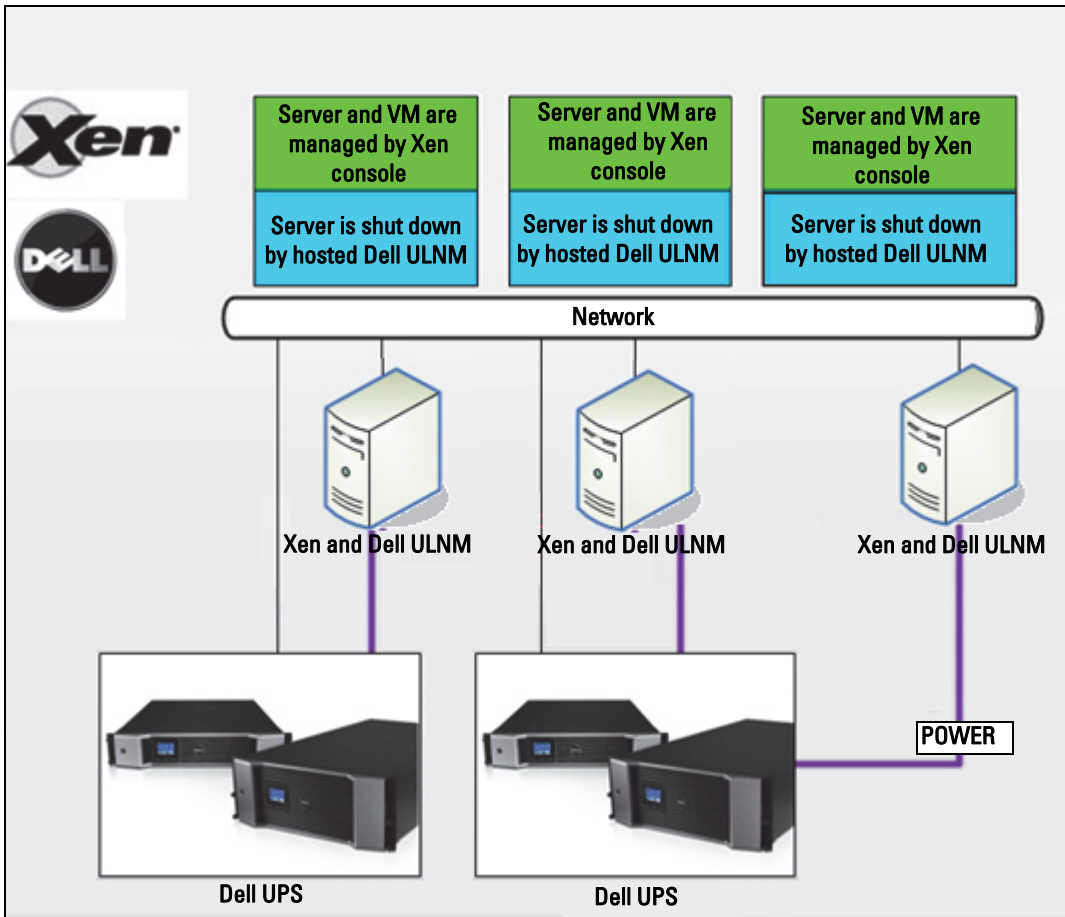

Figure 96. Dell ULNM Solutions for OpenSource Xen

Citrix XenServer Architecture

Figure 97 illustrates the Dell ULNM configuration in a Citrix XenServer architecture.

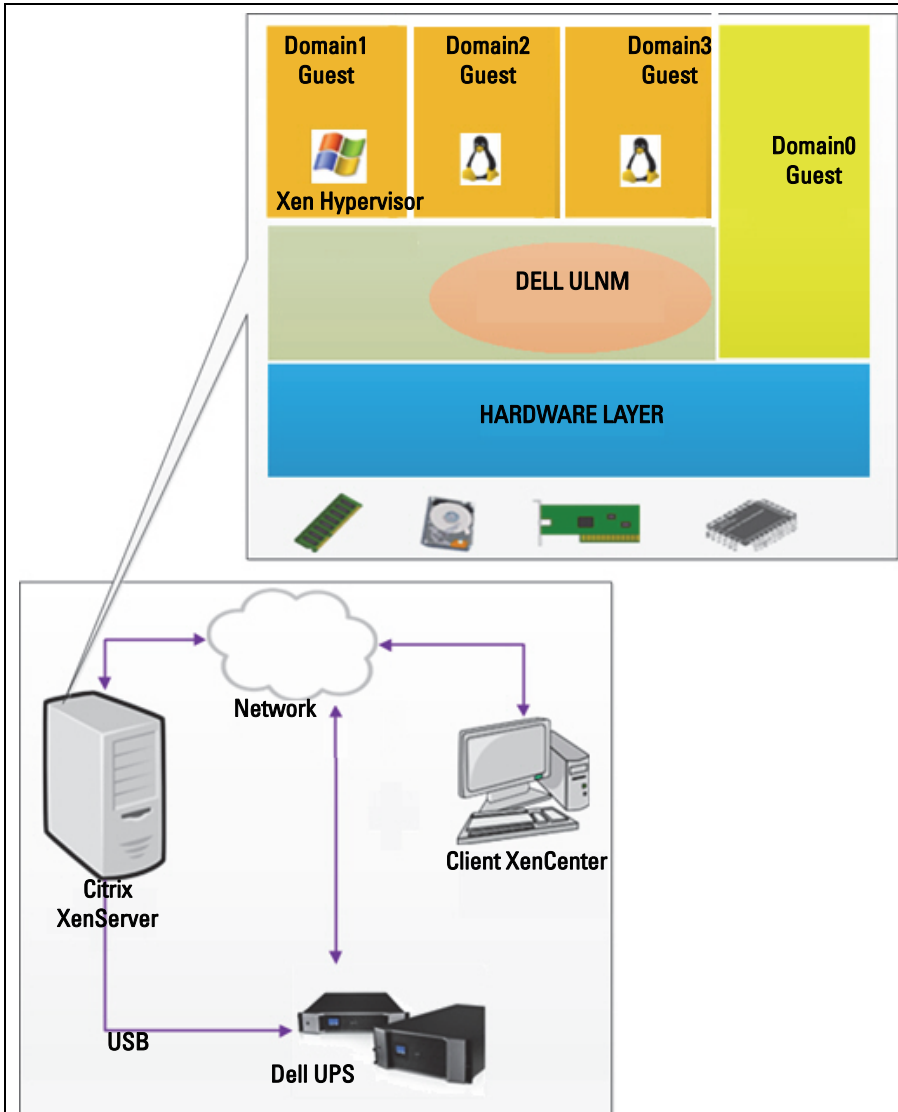

Figure 97. Dell ULNM Configuration for Citrix XenServer Architecture

Installation Prerequisites

This installation and configuration of Dell ULNM has been tested upon following Xen environment:

- Citrix XenServer 5.6 x86

The prerequisites to install Dell ULNM on Citrix XenServer 5.6 x86 machine are as follows:

- XenServer host must have 5 MB free space.
- Dell ULNM installation packages on XenServer
- XenServer and XenCenter should be of same version. For compatibility issues, refer to the XenServer installation guide.
- To allow a graceful shutdown of the virtual machines (VMs), you must install PV Tools (XenTools) on each VM.
- In case of resource pools, if the slave machine shuts down, the master machine will continue functioning. If the master machine shuts down, all guest machines in that pool will go down and the pool will not function until the master is rebooted.

NOTE: The prerequisites for Dell ULNM installation are described in “Installation Prerequisites” on page 13. Also see “Compatibility” on page 10.

Citrix XenServer Configuration Prerequisites

Before installing Dell ULNM on a Citrix XenServer host, the following configurations must be made:

- Hardware support for virtualization must be enabled on the host. This is an option in the BIOS. Consult your BIOS documentation for more details.
- For automatic OS boot on startup, you must configure the physical machine to do the same. This setting is present in BIOS. For further information, see specific technical hardware documentation.
- To allow VMs to function properly in XenServer, it is recommended that PV Tools (XenTools) should be installed on each VM. For further information, see the appropriate XenServer Installation guide.
- Optional auto start of guest machine after host boot.

XenCenter is an administrative console which monitors and manages XenServer hosts and guest machines. To make every VM start automatically, select the check box (it is located in properties of every VM) in XenCenter for the option “Allow virtual machines to start and stop automatically with the system.”

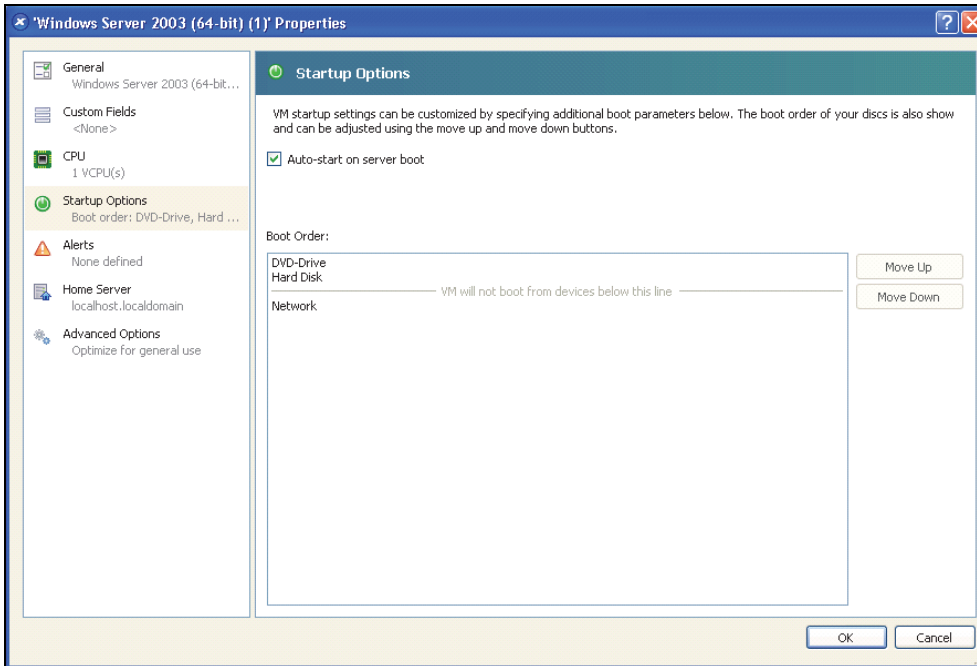

Figure 98. Windows Server 2003 Properties Page

Dell ULNM Installation Prerequisites

The prerequisites for Dell ULNM installation are described in “Installation Prerequisites” on page 13. Also see “Compatibility” on page 10.

Dell ULNM Network Configuration Prerequisites

All hardware elements must have an operational network configuration that allows them to communicate freely with each other.

Ensure that the following TCP/UDP ports are enabled on XenServer firewall:

- Connections on tcp port 4679 and 4680 to enable a remote access for supervision and configuration through the Web browser. These ports are reserved at IANA (<http://www.iana.org>).
- Connections through TCP port 80. It must be opened as a destination port (for output) on the machine hosting the Dell ULNM.

The following is the command line TCP/UPD for configuration 1 to enable communication between the Dell ULNM and Dell Network Management Card:

```
iptables -I OUTPUT -p tcp --dport 80 -j ACCEPT
iptables -I INPUT -p tcp --dport 4679 -j ACCEPT
iptables -I INPUT -p tcp --dport 4680 -j ACCEPT
iptables -I INPUT -p udp --dport 4679 -j ACCEPT
iptables -I INPUT -p udp --dport 4680 -j ACCEPT
iptables -I OUTPUT -p udp --dport 4679 -j ACCEPT
iptables -I OUTPUT -p udp --dport 4680 -j ACCEPT
service iptables save
```

The following is the command line TCP/UPD for configuration 2 to enable communication between the Dell ULNM and Dell UPS Network Management Card:

```
iptables -I OUTPUT -p tcp --dport 80 -j ACCEPT
iptables -I INPUT -p tcp --dport 4679 -j ACCEPT
iptables -I INPUT -p tcp --dport 4680 -j ACCEPT
iptables -I INPUT -p udp --dport 2844 -j ACCEPT
iptables -I INPUT -p udp --dport 2845 -j ACCEPT
iptables -I OUTPUT -p udp --dport 2844 -j ACCEPT
iptables -I OUTPUT -p udp --dport 2845 -j ACCEPT
service iptables save
iptables-save
```

Dell ULNM Installation (Citrix Xen)

To install the Dell ULNM on Dell ULNM on Citrix Xen:

- 1 Download the latest version of the Dell ULNM for Linux from <http://www.dellups.com/>.

NOTE: With the Dell ULNM Release 2, you no longer need to download a separate Xen shutdown script. The Xen shutdown feature is now integrated in standard Dell ULNM Release 2 shutdown script.

- 2 Select **Network solution**.
- 3 Select **Linux** as the Operating Systems.
- 4 Download the Dell UPS Local Node Manager Release 2, rpm Software Installer x86 ulnm-linux-x_xx_xxx-i386.rpm.
- 5 Upload the package on your Xen environment.

- 6 Install the Dell UPS Local Node Manager rpm package on XenServer using the following command:
 - `rpm -i ulnm-linux-x_xx_xxx-i386.rpm`

Silent Installation

- 1 For silent Dell ULNM installation process, please refer to “Silent Installation” on page 25.
- 2 When completed, connect to the Dell ULNM using your Web browser by typing one of the following:
 - For HTTP access: `http://<@IP-or-name-of-XenServer>:4679`
 - For HTTPS access: `https://<@ IP-or-name-of- XenServer>:4680`
- 3 The Dell ULNM interface will be displayed.

References

- <http://www.xen.org/files/Marketing/WhatisXen.pdf>
- <http://www.howtoforge.com/virtualization-with-xenserver-5.5.0>
- <http://docs.vmd.citrix.com/XenServer/4.0.1/reference/ch05s04.html>

RHEL 5 and Debian 5.0 (Lenny) Architecture

Figure 99 illustrates the Dell ULNM configuration for RHEL 5 and Debian 5.0 (Lenny) architecture

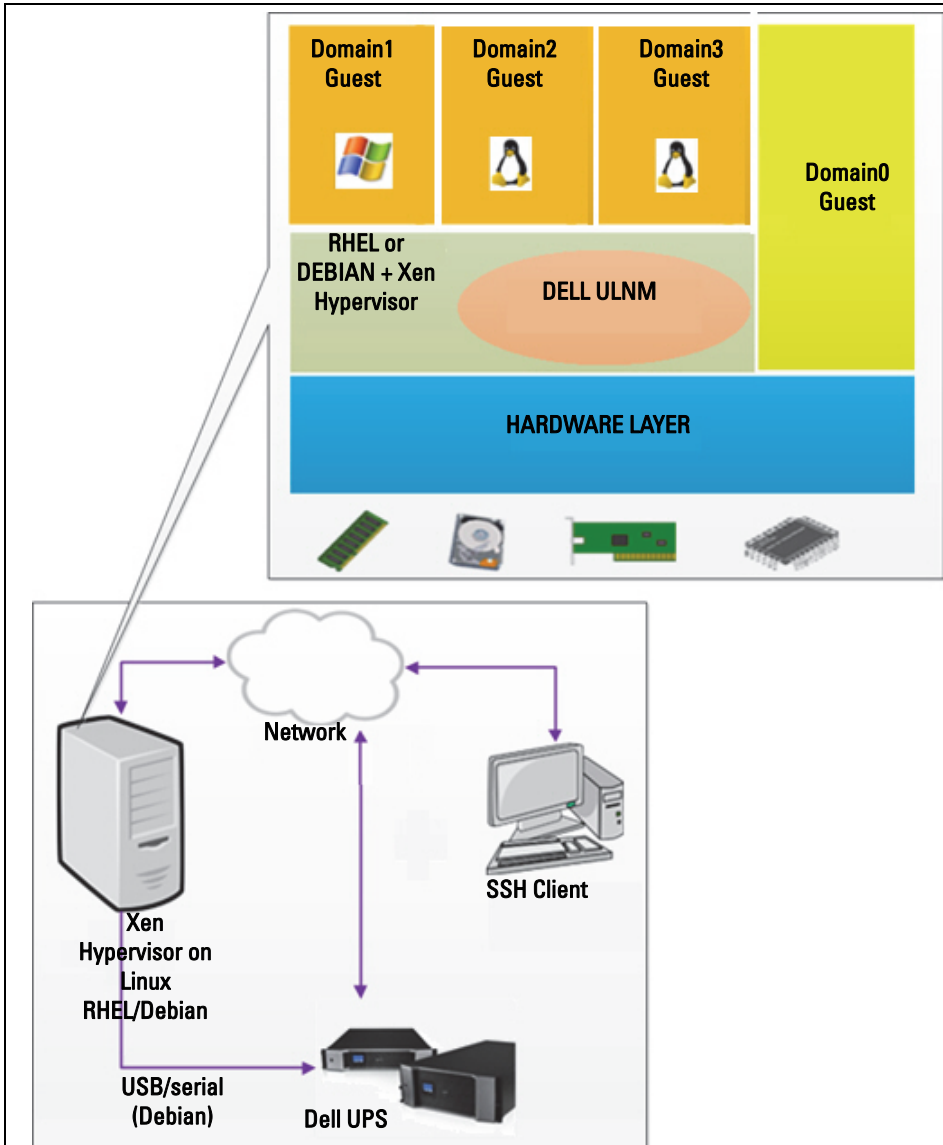

Figure 99. Dell ULNM Configurations for RHEL 5 and Debian 5.0 Architecture

Installation Prerequisites

This installation and configuration of Dell ULNM has been tested upon following Xen environment:

- Red Hat 5 x86_64
- Debian 5.0 (Lenny) x86_64

The prerequisites to install Dell ULNM with Xen enabled on RHEL 5/Debian 5.0 (Lenny) are as follows:

- Xen Hypervisor (on RHEL/Debian) must have 5 MB free space.
- Dell ULNM installation packages on RHEL/Debian.
- To allow a graceful shutdown of the guest VMs, you must install GPL PV drivers on each VM.
- UPSs connected through RS-232 are not supported on RHEL5.

RHEL 5 and Debian 5.0 (Xen Domain0) Configuration Prerequisites

Before installing Dell ULNM on RHEL/Debian (Lenny) where Xen Domain0 is enabled, the following configurations must be made:

- Hardware support for virtualization must be enabled on the host. This is an option in the BIOS. It is possible your BIOS might have virtualization support disabled. Consult your BIOS documentation for more details.
- For automatic OS boot on startup, you must configure the physical machine to do the same. This setting is present in BIOS. For further information, see specific technical hardware documentation.
- In order to allow Windows VMs to function properly, it is recommended that GPL Para virtualized (PV) drivers should be installed on each Windows VM.

Dell ULNM Installation Prerequisites

The prerequisites for Dell ULNM installation are described in “Installation Prerequisites” on page 13. Also see “Compatibility” on page 10.

Dell ULNM Network Configuration Prerequisites

All hardware elements must have an operational network configuration that allows them to communicate freely with each other.

Ensure that the following TCP/UDP ports are enabled on XenServer/Xen Hypervisor firewall:

- Connections on tcp port 4679 and 4680 to enable a remote access for supervision and configuration through the Web Browser. These ports are reserved at IANA (<http://www.iana.org>).
- Connections through TCP port 80. It must be opened as a destination port (for output) on the machine hosting the Dell ULNM.

The following is the command line TCP/UPD for configuration 1 to enable communication between the Dell ULNM and Dell Network Management Card:

```
iptables -I OUTPUT -p tcp --dport 80 -j ACCEPT
iptables -I INPUT -p tcp --dport 4679 -j ACCEPT
iptables -I INPUT -p tcp --dport 4680 -j ACCEPT
iptables -I INPUT -p udp --dport 4679 -j ACCEPT
iptables -I INPUT -p udp --dport 4680 -j ACCEPT
iptables -I OUTPUT -p udp --dport 4679 -j ACCEPT
iptables -I OUTPUT -p udp --dport 4680 -j ACCEPT
service iptables save
```

The following is the command line TCP/UPD for configuration 2 to enable communication between the Dell ULNM and Dell UPS Network Management Card:

```
iptables -I OUTPUT -p tcp --dport 80 -j ACCEPT
iptables -I INPUT -p tcp --dport 4679 -j ACCEPT
iptables -I INPUT -p tcp --dport 4680 -j ACCEPT
iptables -I INPUT -p udp --dport 2844 -j ACCEPT
iptables -I INPUT -p udp --dport 2845 -j ACCEPT
iptables -I OUTPUT -p udp --dport 2844 -j ACCEPT
iptables -I OUTPUT -p udp --dport 2845 -j ACCEPT
service iptables save
iptables-save
```

Dell ULNM Installation (RHEL 5 and Debian 5.0)

Download the latest version of Dell ULNM for Linux from <http://www.dellups.com/> and refer to the installation instructions.

Silent Installation

For silent Dell ULNM installation process, please refer to “Silent Installation” on page 25.

References

- <http://www.xen.org/files/Marketing/WhatisXen.pdf>
- <http://www.howtoforge.com/virtualization-with-xenserver-5.5.0>
- <http://docs.vmd.citrix.com/XenServer/4.0.1/reference/ch05s04.html>

ULNM with KVM Virtualized Architecture

The Dell UPS Local Node Manager (ULNM) discovers and supervises Dell UPSs and PDUs connected across a network, either by means of a card or proxy. It supervises the remote servers hosting the Dell ULNM and also provides local computer graceful shutdown. The Dell ULNM interface can be accessed remotely using a Web browser. Our objective is to provide virtualization support for Dell ULNM power protection software.

The KVM virtualized architecture includes the following:

- KVM 0.12.1.2 on RHEL 6
- KVM 0.12.1.2 on Debian 5.0 (Lenny)

As illustrated in Figure 100, the Dell ULNM is installed on each KVM system and provides a graceful shutdown solution for Red Hat KVM and open-source KVM.

Figure 101 illustrates the Dell ULNM configuration for KVM on RHEL 6 and Debian 5.0 architecture.

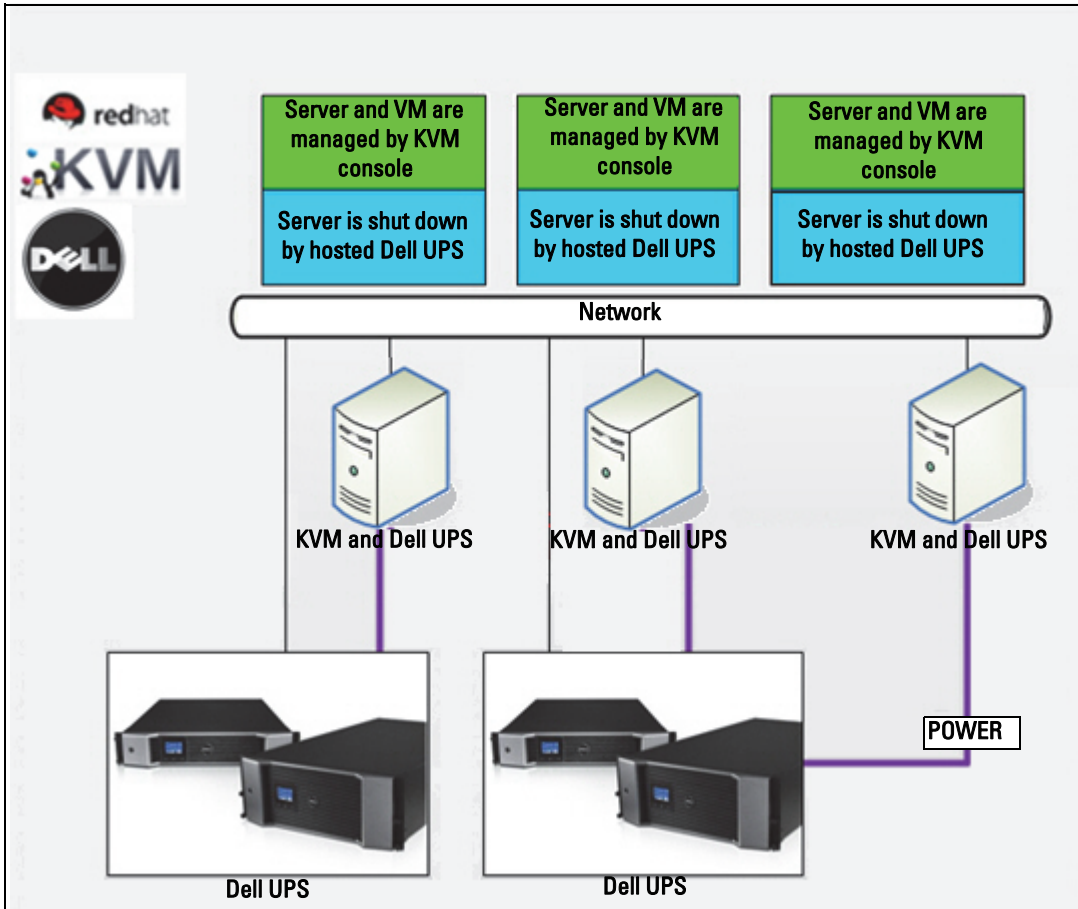

Figure 100. Dell ULNM Solutions for Red Hat KVM or Open-source KVM

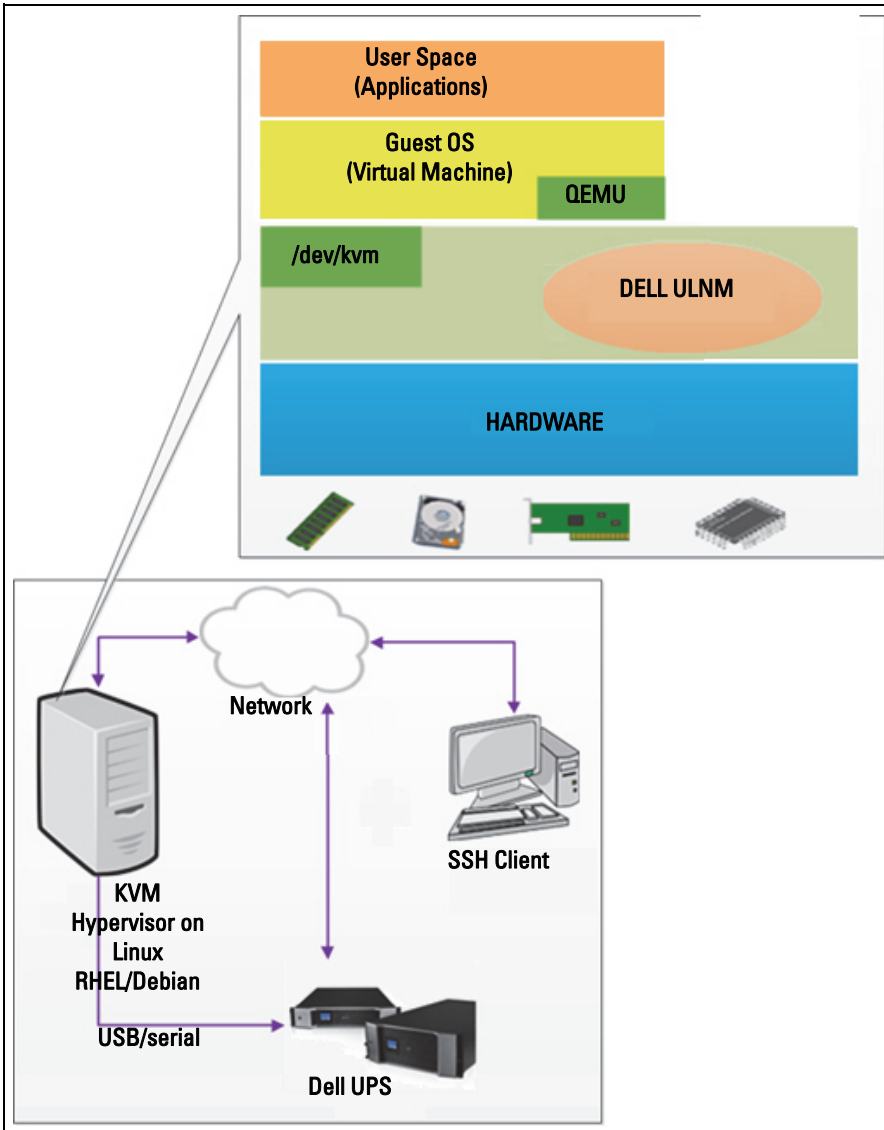

Figure 101. Dell ULNM Configurations for KVM on RHEL 6 and Debian 5.0 Architecture

Installation Prerequisites

The configuration and installation of the Dell ULNM with KVM on RHEL 6 and Debian 5.0 (Lenny) has been tested on the following KVM environment:

- RHEL 6 x86_64 (Red Hat Enterprise Linux v6)
- Debian 5.0 (Lenny) x86_64
- kernel version 2.6.32-71.18.1.el6.x86_64
- qemu-kvm version 0.12.1.2-2.113.el6_0.6.x86_64
- libvirt version 0.8.1-27.el.x86_64
- virt-manager version 0.8.4-8.el6.noarch

The prerequisites to install Dell ULNM on KVM enabled on RHEL6/Debian 5.0 (Lenny) are:

- KVM hypervisor (on RHEL/Debian) having minimum 5 MB free space.
- Dell ULNM installation packages on RHEL/Debian.
- Libvirt packages on RHEL/Debian.

KVM Configuration Prerequisites

Before installing the Dell ULNM on RHEL/Debian 5.0 (Lenny) where KVM is enabled, the following configurations must be made:

- Hardware support for virtualization must be enabled on the host. This is an option in the BIOS. It is possible your BIOS might have virtualization support disabled. Consult your BIOS documentation for more details.
- For automatic OS boot on startup, you must configure the physical machine to do the same. This setting is present in BIOS. For further information, see specific technical hardware documentation.
- Virtio Paravirtualized drivers can be installed for better performance (and are compatible with our solution) but it is optional.
- Optional auto start of guest machine after host boot

Virtual machine monitor (VMM) is an administrative console which monitors and manages guest machines. To make every virtual machine (VM) start automatically, select the “Autostart VM” check box as shown in Figure 102. It is located in VMM (**Hardware > Boot** option) of every VM.

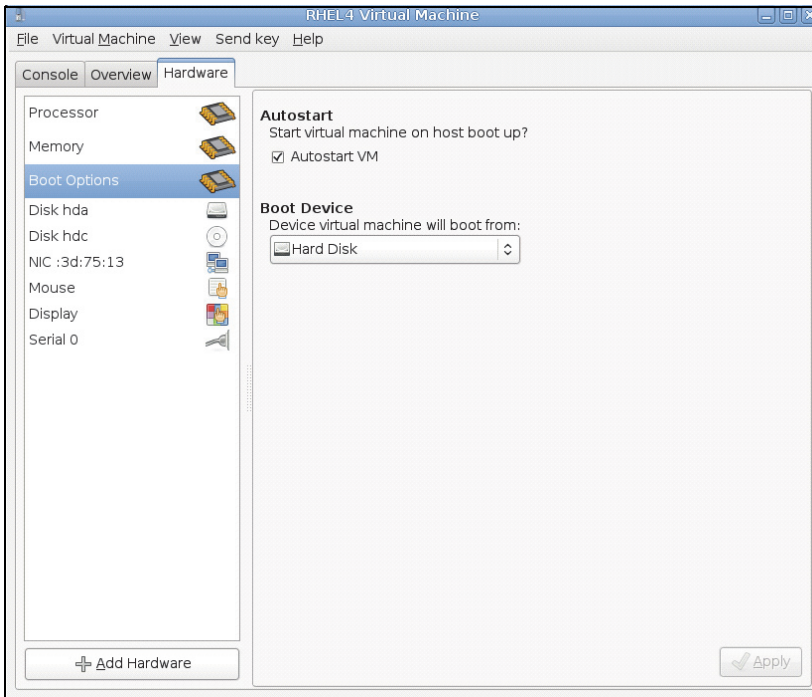

Figure 102. RHEL 4 Virtual Machine Monitor

Dell ULNM Installation Prerequisites

The prerequisites for Dell ULNM installation are described in “Installation Prerequisites” on page 13. Also see “Compatibility” on page 10.

Dell ULNM Network Configuration Prerequisites

All hardware elements must have an operational network configuration that allows them to communicate freely with each other.

Ensure that the following TCP/UDP ports are enabled on KVM hypervisor firewall:

- Connections on tcp port 4679 and 4680 to enable a remote access for supervision and configuration through the Web Browser. These ports are reserved at IANA (<http://www.iana.org>).
- Connections through TCP port 80. It must be opened as a destination port (for output) on the machine hosting the Dell ULNM.

The following is the command line TCP/UPD for configuration 1 to enable communication between the Dell ULNM and Dell Network Management Card:

```
iptables -I OUTPUT -p tcp --dport 80 -j ACCEPT
iptables -I INPUT -p tcp --dport 4679 -j ACCEPT
iptables -I INPUT -p tcp --dport 4680 -j ACCEPT
iptables -I INPUT -p udp --dport 4679 -j ACCEPT
iptables -I INPUT -p udp --dport 4680 -j ACCEPT
iptables -I OUTPUT -p udp --dport 4679 -j ACCEPT
iptables -I OUTPUT -p udp --dport 4680 -j ACCEPT
service iptables save
```

The following is the command line TCP/UPD for configuration 2 to enable communication between the Dell ULNM and Dell UPS Network Management Card:

```
iptables -I OUTPUT -p tcp --dport 80 -j ACCEPT
iptables -I INPUT -p tcp --dport 4679 -j ACCEPT
iptables -I INPUT -p tcp --dport 4680 -j ACCEPT
iptables -I INPUT -p udp --dport 2844 -j ACCEPT
iptables -I INPUT -p udp --dport 2845 -j ACCEPT
iptables -I OUTPUT -p udp --dport 2844 -j ACCEPT
iptables -I OUTPUT -p udp --dport 2845 -j ACCEPT
service iptables save
iptables-save
```

Dell ULNM Installation (KVM Enabled on RHEL 6 and Debian 5.0)

To install the Dell ULNM on KVM Enabled on RHEL 6 and Debian 5.0:

- 1 Download the latest version of Dell ULNM for Linux from <http://www.dellups.com/>.

NOTE: With Dell ULNM Release 2, you no longer need to download a separate KVM shutdown script. The KVM shutdown feature is now integrated in standard Dell ULNM Release 2 shutdown script.

- 2 Select Network solution.
- 3 Select Linux - Xen - KVM as the Operating Systems.
 - For RHEL6 x86_64: Download Dell UPS Local Node Manager Release 2, rpm Software Installer x86_64 for Red Hat (`ulnm-linux-x_xx_xxx-x86_64.rpm`).
 - For Debian 5.0 (Lenny): Download Dell UPS Local Node Manager Release 2, deb Software Installer x86_64 for Debian (`ulnm-linux-x_xx_xxx-x86_64.deb`).

- 4 Upload the package on your KVM environment
- 5 Install the Dell ULNM package:
 - For RHEL6 x86_64: rpm -i ulnm-linux-x_xx_xxx-x86_64.rpm
 - For Debian 5.0 (Lenny): dpkg -i ulnm-linux-x_xx_xxx-x86_64.deb

Silent Installation

For silent Dell ULNM installation process, please refer to “Silent Installation” on page 143.

- 1 When completed, connect to the Dell ULNM using your Web browser by typing one of the following:
 - For HTTP access: <http://<@IP-or-name-of-RHEL/Debian>:4679>
 - For HTTPS access: <https://<@ IP-or-name-of- RHEL/Debian>:4680>
- 2 The Dell ULNM interface will be displayed.

References

- <http://www.linux-kvm.org>
- <http://www.tuxradar.com/content/howto-linux-and-windows-virtualization-kvm-and-qemu>
- <http://www.redhat.com/f/pdf/rhev/DOC-KVM.pdf>

Troubleshooting

This chapter describes troubleshooting for the Dell UPS Local Node Manager (ULNM).

Messages or Issues and Solutions

HTML pages

Cannot display the UPS properties page. HTTP 404 error with IE.

Solution:

- Check the URL entered.
https://<name or IP of the computer hosting Dell ULNM>:4680/
or
http://<name or IP of the computer hosting Dell ULNM>:4679/

Ubuntu's Software Center

"The package is of bad quality"

Solution:

- This is a known issue specific to Ubuntu Software Center. Click the "ignore and install" button.

Linux Graphical System Integration

Linux, Debian, and Ubuntu, with Gnome: "Open" shortcut is not present

Solution:

- The menu shortcut will appear the next time you launch Gnome.
In the meantime, open a Web browser and enter the following URL:
http://localhost:4679/

Linux OpenSUSE 11, with KDE: "Open" shortcut is not visible

Solution:

- To find ULNM icon, use the Search function from the Application Menu. You should then find the Dell ULNM icon in the Favorites section.

Linux Red Hat, OpenSUSE and Mandriva: Notification icon (system tray icon) is not started upon installation or upgrade

Solutions:

- Launch the following command, as your standard user, from a terminal or using a Launch feature:

```
$ /usr/local/Dell/UPSLocalNodeManager/mc2 -systray
```

NOTE: If you launch this command from a terminal, add an ampersand (&) at the end of the command line in order to detach the process.

- Close your graphical session, and log into a new one. The notification icon will be automatically start with the new graphical session

Linux Unity desktop: "Open" shortcut is not present

Solutions:

- Open a terminal and type the following line:

```
> sudo xdg-desktop-menu install --novendor  
/usr/local/Dell/UPSLocalNodeManager/desktop/Dell.directory  
/usr/local/Dell/UPSLocalNodeManager/desktop/ULNM.directory  
/usr/local/Dell/UPSLocalNodeManager/desktop/Open.desktop
```

- Type **open** in the search box of the Unity Menu to retrieve the "Open" shortcut.
- Open a Web browser and type the following URL:

```
http://localhost:4679/
```

Linux Network System Integration

Network proxy not detected

NOTE: If your network proxy was not detected during installation, you will not be able to access automatic update and other Internet resources from the Dell ULNM. This can be validated by the absence of "proxy.cfg" under /usr/local/Dell/UPSLocalNodeManager/configs/

Solution:

- Create a file named "proxy.cfg" under /usr/local/Dell/UPSLocalNodeManager/configs/ with the following content:

```
{  
  'proxyHost' : "your.proxy.address.com",  
  'proxyPort' : "proxy_port"  
}
```

For example:

```
{  
  'proxyHost' : "proxy.domain.com",  
  'proxyPort' : "8080"  
}
```

Then, restart the Dell ULNM to reload the configuration

Dell ULNM Linux displays the Network “Communication Lost” alarm after 20 minutes

Solution:

- Improvement in the next release.

When Activating Shutdown Controller under Linux

When you enable the Shutdown Controller optional module, a problem in the Dell ULNM service initialization occurs.

Solution:

- The issue can be easily solved by restarting the Dell ULNM daemon once the “Shutdown Controller” module has been activated. There is no need to restart the Dell ULNM daemon when disabling this feature.

Events and Actions with Some Windows x64 bits OS

When the shutdown command is called from the Dell ULNM context, the system doesn't find it because it searched in C:\Windows\SysWOW64 even if the specified path is explicitly C:\Windows\System32\shutdown.exe.

NOTE: This is a problem of some Windows x64 OS versions (e.g. XP x64 and 2003 x64). For example, this problem doesn't appear on Windows 7 x64.

Solution:

- Retrieve “shutdown.exe” from the C:\Windows\System32\ folder and copy it into D:\ULNM\ for example. Then modify “shutdown.bat” to explicitly call D:\ULNM\shutdown.exe

Windows Vista Hibernate Sequence

By default, the Dell ULNM runs an Operating System “Hibernate.” Unfortunately, the “Hibernate” option of Windows Vista is sometimes no longer available after performing a disk cleanup. In this case, Windows Vista “Hibernate” fails.

Solutions:

- Change the Dell ULNM shutdown configuration from “Hibernate” to “Shutdown.”
- Execute the command “Powercfg -h on” under an administrator account to restore the Windows Vista “Hibernate” option.

<http://support.microsoft.com/default.aspx?scid=kb;EN-US;928897#LetMeFixItMyself>

Shutdown Sequence

When connected through a serial RS-232, Pulsar UPSs sometimes do not shut off as expected. In this case, the UPS does not take into account the “Shutdown Duration” parameter of the Dell ULNM.

Solution:

- Use a USB connection. The next Dell ULNM version will implement this correction in RS-232.